

ALMA MATER STUDIORUM - UNIVERSITÀ DI BOLOGNA

---

SCUOLA DI INGEGNERIA E ARCHITETTURA

DIPARTIMENTO DI ARCHITETTURA

(DA)

*CORSO DI LAUREA IN INGEGNERIA EDILE-ARCHITETTURA*

TESI DI LAUREA

In

Progettazione Sostenibile

**Energy and architectural renovation towards nZEB  
The Dutch Scheveningen case in the ABRACADABRA Project**

CANDIDATA

Maria Sofia Pitulis

RELATORE:

Chiar.ma Prof.ssa Annarita Ferrante

CORRELATORE:

Giovanni Mochi

CORRELATORE ESTERNO:

Nico Nieboer

Anno Accademico 2015/2016

Sessione III



# Energy and architectural renovation towards nZEB

## The Dutch Scheveningen case in the ABRACADABRA Project

### Table of contents

1	Introduction .....	9
1.1	Motivation.....	9
1.2	Statement of the problem.....	10
1.3	Methodology.....	11
1.3.1	Literature Review.....	12
1.3.2	Design Case Study .....	12
2	Energy efficiency measures.....	12
2.1	Introduction .....	12
2.2	Green building construction and cities' densification.....	13
2.3	The existing housing stock in Europe .....	13
2.4	The existing housing stock in the Netherlands .....	16
2.5	European policies .....	16
2.5.1	Definition of energy renovation in EU legislation .....	19
2.6	The Dutch policies.....	20
2.6.1	Introduction .....	20
2.6.2	Energy labels.....	20
2.6.3	Energiesprong .....	22
2.6.4	The non-profit housing sector.....	23
2.6.5	The private sector.....	25
3	The energy demand of the heating system.....	26
4	Add-ons as a strategy .....	27
4.1	Introduction .....	27
4.2	The strategy .....	27
4.3	ABRACADABRA Project.....	28
5	Examples .....	28
5.1	Introduction .....	28
5.2	The Himmerland Housing Association, Departments 19 & 22.....	28
5.3	The 'Bois Le Prêtre' tower metamorphosis.....	29
5.4	The Giesshübel pile up.....	30
5.5	Tower and line social housing blocks in Bologna .....	31
6	Analysis of the actual state of the Case Study .....	33

6.1	Environmental and physical climatic criticalities .....	33
6.1.1	Location .....	33
6.1.2	Road network and permeability .....	34
6.1.3	Sun and temperatures .....	35
6.1.4	Wind Rose .....	37
6.1.5	Sun, wind and rain combination .....	38
6.2	Construction criticalities .....	39
6.2.1	Brief history of the buildings .....	39
6.2.2	Insulation and windows .....	42
6.2.3	Distribution of functions .....	43
6.2.4	Ventilation .....	45
6.2.5	Buildings' deterioration.....	45
6.3	SWOT Analysis .....	46
6.4	Energy Demand as built.....	48
7	Design phase .....	53
7.1	Energy renovation of the existing .....	54
7.2	Energy Demand as designed .....	58
7.3	Local regulations on physical planning .....	64
7.4	The actual design.....	65
7.5	The parameters.....	65
7.6	Scenarios of feasibility of the investment .....	66
7.6.1	Scenario zero.....	68
7.6.2	First scenario.....	69
7.6.3	Second scenario .....	70
7.6.4	Third scenario.....	71
7.6.5	Fourth scenario .....	72
7.7	Master plan.....	73
7.7.1	Demolition .....	73
7.7.2	Plan.....	74
7.8	Proposal.....	75
7.8.1	Wooden structure .....	75
7.8.2	Winter gardens.....	78
7.8.3	Rooftop additions.....	85
7.8.4	Assistant building.....	101
7.9	Technical details .....	104
7.10	Energy demand of the project .....	106

8	Conclusions and recommendations .....	110
8.1	Conclusions .....	110
8.1.1	Process summary .....	110
8.1.2	Examples conclusions.....	111
8.1.3	Dutch case study conclusions .....	112
8.2	Recommendations .....	116
8.2.1	Recommendations for further research .....	116
8.2.2	Recommendations for other practices .....	116
9	Bibliography.....	116
10	Sitography.....	117

## List of Figures

Figure 2.1 Building in the district of Kypseli, Athens (source: google images)

Figure 2.2 1967 Residential building in Scheveningen, The Hague (source: author)

Figure 2.3 Brief timeline of European energy policies (source: author)

Figure 2.4 Energiesprong's business model (source: author)

Figure 2.5 Oud-Vossemeer, example of Energiesprong's work (source: [www.energiesprong.nl](http://www.energiesprong.nl))

Figure 2.6 Percentage of dwellings with energy efficiency measures applied and not (source: author)

Figure 2.7 Percentages of energy efficiency measures applied (source: author)

Figure 3.1 Energy Gains and Dispersions scheme for a house (source: author)

Figure 5.1 Sustainable precautions and pictures of the construction phases (source graphics: author, source pictures: [www.cfmoller.com](http://www.cfmoller.com))

Figure 5.2 Sustainable precautions and pictures of the construction phases (source graphics: author, source pictures: [www.druot.net](http://www.druot.net))

Figure 5.3 Sustainable precautions, pictures, section and floor plan (source graphics: author, source pictures: [www.burkhalter-sumi.ch](http://www.burkhalter-sumi.ch))

Figure 5.4 Sustainable precautions, renderings and technical detail (source: author)

Figure 6.1 Map of The Hague with division of districts and focus on Scheveningen (source: author)

Figure 6.2 Focus on case study buildings (source: author)

Figure 6.3 View of Scheveningen's beach (source: author)

Figure 6.4 Principal transport routes and green areas near the case study buildings (source: author)

Figure 6.5 Different shading scenarios following the seasons and mainly shaded areas (source: author; software: Autodesk Ecotect Analysis)

Figure 6.6 Wind directions (source: author)

Figure 6.7 Combination of wind and shading in winter period (source: author; software: Autodesk Ecotect Analysis)

Figure 6.8 Partition in blocks A and B and related civic numbers (source: author)

Figure 6.9 Available documents from the cadastre (1920-1929) (source: Urban Climate Architects)

Figure 6.10 Available documents from the cadastre (1931-1938) (source: Urban Climate Architects)

Figure 6.11 Available documents from the cadastre (1946-1947) (source: Urban Climate Architects)

Figure 6.12 Available documents from the cadastre (1960-1969) (source: Urban Climate Architects)

Figure 6.13 Windows distinction, percentages of windows type per block and ratios between windows area and wall area per orientation (source: author)

Figure 6.14 Partition of dwellings for each floor (source: author)

Figure 6.15 Blocks' dimensions (source: author)

Figure 6.16 Inner ventilation in the dwellings (source: author)

Figure 6.17 Brick types and buildings' deterioration (source: author)

Figure 6.18 SWOT Analysis: strengths

Figure 6.19 SWOT Analysis: weaknesses (source: author)

Figure 6.20 SWOT Analysis: opportunities and threats (source: author)

Figure 6.21 Architectural components' details: layers, thicknesses and thermal transmittances (U) (source: author)

Figure 6.22 Daily average irradiation on north and south facades during winter period (source: author; software: Autodesk Ecotect Analysis)

Figure 7.1 New roof's layers (source: author)

Figure 7.2 New ground floor's layers (source: author)

Figure 7.3 New walls' layers (source: author)

Figure 7.4 Maximum surfaces and heights of rooftop additions on blocks A and B and new constructions in demolition area (source: author)

Figure 7.5 Actual project: Urban Climate Architects (source: Urban Climate Architects)

Figure 7.6 Parameters of comparison between the projects (source: author)

Figure 7.7 Economic values for the scenarios (source: author)

Figure 7.8 First scenario: adhesions (source: author)

Figure 7.9 Second scenario: rooftop additions (source: author)

Figure 7.10 Third scenario: adhesions, rooftop additions and assistant buildings (source: author)

Figure 7.11 Demolition area (source: author)

Figure 7.12 Master plan: before and after the intervention, percentages of permeable, impermeable and semipermeable soil, type of trees and bushes, evolution of the concept (source: author)

Figure 7.13 Different shading scenarios following the seasons (source: author; software: Autodesk Ecotect Analysis)

Figure 7.14 Cross and Glue laminated timber (source: [www.kirhammond.wordpress.com](http://www.kirhammond.wordpress.com))

Figure 7.15 UBC's tall wood building, Brock Commons (source: [www.news.ubc.ca](http://www.news.ubc.ca))

Figure 7.16 UBC's wooden structure and gypsum boards encapsulation (source: [www.hermann-kaufmann.at](http://www.hermann-kaufmann.at))

Figure 7.17 Thermal coat addition and steel pillars to sustain the rooftop addition: ground, first and second floor (source: author)

Figure 7.18 Scheme of the new volumes: winter gardens (source: author)

Figure 7.19 Scheme of the adhesions to the existing dwellings: before and after dimensions (source: author)

Figure 7.20 Ground floor plan: before and after the intervention (source: author)

Figure 7.21 First floor plan: before and after the intervention (source: author)

Figure 7.22 Composition scheme of the new volumes (source: author)

Figure 7.23 Winter garden module and external stairs for dwelling (f) (block B) (source: author)

Figure 7.24 Location of movable and unmovable brise soleil: ground and first floors (source: author)

Figure 7.25 Renders (source: author)

Figure 7.26 South facade view: winter gardens (source: author)

Figure 7.27 Scheme of the new volumes: rooftop additions (source: author)

Figure 7.28 Rooftop additions: structure (source: author)

Figure 7.29 Seismic mapping of the Netherlands and The Hague location (source: Seismic Hazard Harmonization in Europe, 2013)

Figure 7.30 Abacus for different family units combinations (source: author)

Figure 7.31 Chosen facade composition for blocks A1 and A2 rooftop additions (source: author)

Figure 7.32 Second floor plan: rooftop additions blocks A1 and B (source: author)

Figure 7.33 Third floor plan: rooftop additions blocks A1, A2 and B (source: author)

Figure 7.34 Fourth floor plan: rooftop additions blocks A1, A2 and B (source: author)

Figure 7.35 Fifth floor plan: rooftop additions block A2 (source: author)

Figure 7.36 Internal partition of the apartment: elderly couple (source: author)

Figure 7.37 Internal partition of the apartment: young couple (source: author)

Figure 7.38 Internal partition of the apartment: family (source: author)

Figure 7.39 Internal partition of the apartment: studio (source: author)

Figure 7.40 Architectural component: winter garden (source: author)

Figure 7.41 Architectural component: balcony (source: author)

Figure 7.42 IJburg houses (source: google images)

Figure 7.43 Internal partition of the apartment: rooftop addition on block B (source: author)

Figure 7.44 Abacus of the main architectural components: roof, walls and facade (source: author)

Figure 7.45 Rooftop additions: perspective north and south views renders (source: author)

Figure 7.46 Rooftop additions: north and south facades renders (source: author)

Figure 7.47 Scheme of the new volumes: assistant building (source: author)

Figure 7.48 Assistant building's structure (source: author)

Figure 7.49 Assistant buildings' ground and first floor plans (source: author)

Figure 7.50 Assistant buildings' internal partition: ground floor (source: author)

Figure 7.51 Assistant buildings' internal partition: first floor (source: author)

Figure 7.52 Assistant buildings: north and south facade renders and perspective render south view (source: author)

Figure 7.53 Technical detail: connection between pillar and existing brick wall (source: author)

Figure 7.54 Technical detail: existing building's new roof (source: author)

Figure 7.55 Technical detail: 3D connection between pillar and existing brick wall and existing building's new roof (source: author)

Figure 7.56 3D detail of the existing buildings' new wall: thermal transmittance and layers' thicknesses (source: author)

Figure 7.57 3D details of the architectural components of the assistant buildings, with thermal transmittances and layers' thicknesses: roof, wall and ground floor (source: author)

Figure 7.58 Photovoltaic panels on rooftop additions (source: author)

### List of Tables

- Table 2.1 Different Energy labels and Indexes depending on different Primary Energy Consumption, valid until 2014 (source: author)
- Table 6.1 Thermal transmittances: roof, ground floor and walls (source: author)
- Table 6.2 PEI and annual energy cost for block A (source: author)
- Table 6.3 PEI and annual energy cost for block B (source: author)
- Table 7.1 New thermal transmittances: roof, ground floor and walls (source: author)
- Table 7.2 PEI and annual energy cost for block A after energy renovation (source: author)
- Table 7.3 PEI and annual energy cost for block B after energy renovation (source: author)
- Table 7.4 Photovoltaic surface needed and total cost for blocks A and B (source: author)
- Table 7.5 PEIs comparison: proposed interventions and national standard interventions
- Table 7.6 Summary data from the scenarios (source: author)
- Table 7.7 PEI, photovoltaic square meters needed and photovoltaic cost: existing refurbished buildings + winter gardens, rooftop additions & assistant buildings (source: author)
- Table 7.8 PEI, photovoltaic square meters needed and photovoltaic cost: existing refurbished buildings, rooftop additions & assistant buildings (source: author)
- Table 8.1 Process summary and objectives (source: author)
- Table 8.2 Main characteristics of the add-ons examples (source: author)
- Table 8.3 Final surfaces: Dutch case study (source: author)
- Table 8.4 Summary table about scenarios' data (source: author)

### List of Graphs

- Graph 2.1 Age of dwellings in Northern Europe (source: author)
- Graph 2.2 Flows of materials, energy and water of consolidation, transformation and new construction (source: author)
- Graph 5.1 Temperatures and rain statistics, Rotterdam Airport Meteorological Station (source: author)
- Graph 6.1 Cumulative scenarios for block's A PEI in kWh/sqm year (source: author)
- Graph 6.2 Cumulative scenarios for block's B PEI in kWh/sqm year (source: author)
- Graph 6.3 Different energy efficiency measures combinations for block A in kWh/sqm year (source: author)
- Graph 6.4 Different energy efficiency measures combinations for block B in kWh/sqm year (source: author)
- Graph 6.5 Summary graph about scenarios' data (source: author)



# Abstract

The motivation to apply energy efficiency measures to existing buildings is that the built environment is greatly responsible for the CO<sub>2</sub> emissions and for the energy use of Europe. Since that, a strategy must be found that could lead to the creation of a new market for energy renovation of existing buildings. The ABRACADABRA add-ons strategy is one possible solution as it has been thought in order to overtake the feasibility problems related to the energy renovation interventions on buildings. Hence, the major objective of this study is to identify the necessary conditions that could make possible an add-ons strategy intervention for an existing case study, concerning the normative, architectural, economic and technologic issues. For these purposes, a mixed research was carried out, including a literature review, the analysis of existing case studies and the design of add-ons on a Dutch case study. The literature review presents the 'state of the art' of energy efficiency interventions in the existing housing stock in Europe and the European regulation elaborated for this purpose. Then, the analysis of case studies, seen as best practices, was useful in order to investigate the effective feasibility of the add-ons strategy. The central part of this thesis, consists of the investigation of a new case study, an existing block of buildings in The Hague, in the Scheveningen district. Initially, a detailed analysis of the actual state was carried out, by stating the SWOT analysis for the construction. Then, the calculation of the energy demand was carried out in order to state the consequent energy measures to be applied on the existing buildings. Moreover, different scenarios based on the cost-benefit analysis were elaborated in order to check the boundaries of the intervention's feasibility. Finally, the design process was carried out with details about the technical realization of the new construction. Concluding, this research indicates the conditions that could lead to a feasible add-ons intervention on an existing building in need of energy renovation. As an outcome of the Scheveningen case study, it is suggested to introduce the add-ons strategy as a normal practice in building energy refurbishment, regarding the benefits and perspectives that have been revealed for both owners and tenants on the basis of energy efficiency and construction costs.

## 1 Introduction

### 1.1 Motivation

Referring to the latest legislative decisions of the EU community, the definition of a very high energetic performance building refers to its energy demand that has to be very low or null, and has to be covered in a significant way by renewable energies (2010/31/EU). Today only 1.2% of Europe's existing buildings is renovated per year, which is due to the high investments required for deep renovation and the high degree of risk combined with long payback times. One of the ways to soften this obstacles could be carried on by the design process through an architectural transformation of the building. The technological changes applied to the existing construction in order to reach a nZEB status constitute the aim of the process and consist of several interventions regarding the reduction of energy consumption, the use of renewable energies and a more efficient use of energy in order to reduce the losses. It is clear that a strategy is needed in order to make this transformation process successful. Going deep in the issue, money is required in order to make all this possible and, as the core of the discussion is the building, a plan based on the real estate dynamics could be the solution. In fact, additional volumes to the existing buildings could counterbalance the energy retrofitting costs with their economic value in the housing real estate. Not only, but the addition of

volumes, and more specifically the adhesion of them to the existing constructions thought in the sense of a bioclimatic approach, could also contribute itself to the decrease of the primary energy demand of the building.

The aim of this project is to apply this strategy to a Dutch case study, evaluating its probabilities of success and above all its economic feasibility. It will be clarified whether for private owners this method could be convenient or not and which are the factors that might improve its success.

One of the initial tasks is to elaborate the design of the new volumes that has to be compatible with the existing body in terms of architectural composition, and this will be possible if the design process will be developed following the conditions produced by the initial analysis of the existing building. What is more, another initial issue is to establish the field of action of the project, depending on the parameters and restrictions imposed by the regulation, for what concerns the refurbishment of an existing building. The research questions refer to the economic feasibility of the intervention. Supposed that the private owner wants to invest in the energy retrofitting of the building, is it actually possible to have a return of the money invested in a "short" period? For "short" it is supposed that the owner would have the economic capability to wait for the total return of the money spent and also expect a possible profit from the intervention.

## 1.2 Statement of the problem

Sustainability in architecture has always been seen as something abstracted and theoretical with difficult practical implementation. Frank Lloyd Wright (1939) was one of the first authors who elaborated ideas about this topic: the architectural design has to build a new balance between the built and the natural environment through the integration of the elements created by men and the natural ones present in the field. One of the main reasons why architecture has to change perspective is strictly related to the actual conditions of the energy supplies on earth. It has been evaluated that there would be enough coal to supply the energy demand for the next two centuries but for what concerns gas, it will be available for other 69 years while oil for only 43 years (Itard, 2012). It is clear that a drastic turnover into renewable resources has to be done. Architecture is one of the disciplines that has the responsibility to act in the foreground for this aim. That is due to the impact of energy consumption of the existing buildings that account for approximately 40% in the European Union. More specifically 30% of the energy of the total building stock on average is consumed by the households. Because of this, the citizens have to change their habits in the perspective of a sustainable way of living and architecture has to provide the appropriate means to success in that purpose.

The answer to this need is to implement energy efficiency measures in the housing sector. To do that economic investments are needed and they represent the crucial aspect of the process. The only way to convert this sporadic phenomenon into a widespread approach to the housing stock sector is to make it attractive in economic terms.

In particular, the thesis analyses the possibility to counterbalance the investment on the energy renovation of a building by the construction of new volumes that would be rented or sold. The main task is to evaluate whether the add-ons strategy could be a feasible approach to convert buildings into nZEB.

Regarding the elaboration of the thesis, a research question has been fixed:

Which are the necessary conditions that could lead to the feasibility of the add-ons strategy on the case study, in normative, architectural, economic and technologic terms?

### 1.3 Methodology

The research method consists of an initial phase of understanding the framework in which the case study is set. It gives a description of the current economic and political Dutch scenarios, before moving to a focus onto the existing housing's stock situation in the Netherlands and the past and current policies approved by the government in terms of energy efficiency measures. The study is brought forward in relation to the European background.

Then it is explained in more detail in what consists the add-ons strategy for the renovation of existing buildings and some examples of this type of intervention are described in order to show the best practices in this field. The example case studies are integrated in the literature review as means to support and validate the literature research. The projects are the following:

- The Himmerland Housing Association, Departments 19 & 22 in Aalborg (Denmark) by C. F. Moller Architects. (2009-2016)
- The 'Bois Le Pretre' Tower Metamorphosis in Paris by Frederic Druot Architecture. (2011)
- Giesshübel pile up in Zürich by Burkhalter Sumi Architekten. (2013)
- Tower and line social housing blocks in Bologna by Giulia Fanin, Maria Sofia Pitulis, Fabrizio Ungaro (master students of Architecture and Building Engineering at the University of Bologna). (2016)

The first example is about the renovation of homes by their transformation and rooftop addition. The second example refers to the addition of terraces and winter gardens to the existing block. The third example, as the first one, regards a rooftop addition on an ancient storage building, while the last one regards a proposal for the energy renovation and design of adhesions, rooftops additions and assistant buildings for '70s social housing tower and line blocks. All strategies have been carried on to lead to an energy retrofitting of the constructions, made it possible, in economic terms, thanks to the counterbalancing of the investments by the decrease of the energy demand and by the creation of new volumes.

The central part of the research is based on the Dutch case study, in particular on the design of volumetric additions in order to go through the add-ons method that has to be evaluated. This phase consists of several steps, beginning with the analysis of the actual state of the building, ending with the technical details of the construction process.

The design case study is used to validate the outcomes of the literature review and to be able to answer to the research question. The case study is composed by a block of neighbouring buildings in the district of Scheveningen in The Hague, owned by an architecture studio. The thesis will develop a proposal for the volumetric addition on the existing and will validate its feasibility highlighting the necessary conditions for it. The existing buildings are analysed in order to verify the current state and state the fundamentals for the following design phase.

As last, the research is rounded off by answering to the initial questions that characterised the thesis. As a consequence, a critical evaluation is provided and related suggestions are elaborated.

### 1.3.1 Literature Review

The literature review is needed to explore the following topics:

- An overview on the actual state of the existing housing stock in Europe concerning the energy demand of dwellings and the eventually energy efficiency measures applied on them.
- An overview on the energy efficiency European policies elaborated and specifically the Dutch approach to these issues, also describing the Energiesprong approach as a developing strategy for existing social housing owned dwellings in the Netherlands.
- A description of the add-ons strategy as a possible solution in order to overtake the economic obstacles connected to the feasibility of energy renovation interventions.
- An explanation of the best practices in energy renovation of buildings and the measures adopted.

### 1.3.2 Design Case Study

The Design of the Case study considers the following issues:

- An examination of the economic influence of adding storeys to the existing buildings, in order to counterbalance the energy efficiency measures costs with the selling of the new dwellings.
- The identification of the parameters that play the most important role in defining the add-ons intervention for the case.
- A comparison between the several incremental design scenarios.
- The development of useful directives that could be used for owners and investors for the energy renovation of existing buildings using the add-ons strategy.

## A. Literature Review

## 2 Energy efficiency measures

### 2.1 Introduction

In 2010 the European Union has stated that, respectively by 2018 and 2020, new public and not public buildings should be nearly zero energy. The European Directive 2010/31 gives the definition for nZEB as a building with a very high energy performance, whose energy demand is very low or null and must be mainly covered by renewable energies; moreover its energy performance must involve the lowest cost during the economic life cycle estimated (art.2). This definition is addressed to new constructions, but what is about the existing buildings? In order to fulfil the energy savings directions stated by the European Union, it is necessary to intervene also on the existing housing stock, which, besides, is responsible for 30% of European CO<sub>2</sub> gas emissions.

Following the most recent European normative concerning the reduction of CO<sub>2</sub> emissions, the energy savings and the increase of use of renewable energies (2030 targets), a nearly zero-energy renovation strategy needs to be applied to the existing buildings in order to participate in the European sustainability goals.

Furthermore, the first step to move forward is related to the housing stock as, between the several construction sectors, is the most responsible for fuel consumption.

## 2.2 Green building construction and cities' densification

The context in which the Green Building approach was born, is the First Energy Crisis (1973), during the Kippur War (Syria, Egypt, Israel), when, for the first time, there was concern about the non-renewable nature of oil. This led to spread more awareness about the instability of the energy production system and new terms, as *Ecology* and *Energy Saving*, began to be used. Later on, a second Energy Crisis was stimulated by the Iranian Revolution in 1979. Energy became the very first cause of the related economic crisis and this revealed, once more, the strong dependence of the world upon oil resources. The energy saving was the first answer to the question regarding the solution of the crisis. The most developed countries began to implement architecture discipline with sustainability measures, understanding that the design process was the very first step that could lead to an energy saving construction. This awareness did not find real concrete application, as today the majority of the buildings in need of energy retrofitting are those built in the 70s and 80s, but at least theoretically reflections were elaborated upon this issues.

Talking about the housing sector, an overview about the cities in which we live must be done. The approach that coherently should be attributed to the government of the cities need to be strictly related to the aim of the renovation of the existing buildings. As the main concern is to fix the existing constructions in order to make them environmentally compatible, the same behaviour must be followed, at a larger scale, while managing the city. As Jaime Lerner (Brazilian architect and Mayor of Curitiba) suggests, it must be applied an *Urban Acupuncture* that fixes the "ill" parts of the cities through circumscribed interventions in the more needy contexts. The general idea is that specific and effective renovation has always to be preferable than demolition and loss of permeable soil. Moreover, using the Life Cycle Assessment method, it is clearly revealed that renovation and interventions on the existing are always preferable than demolition and reconstruction, in terms of materials and energy savings.

## 2.3 The existing housing stock in Europe

Most of the existing housing stock in Europe was built after WW II with a mass production on a huge scale approach. These buildings largely satisfy the housing needs, nevertheless they are characterised by poor quality of the construction that is connected to the high energy demand of these buildings and consequently to the pollution caused by them. (Itard, 2008)

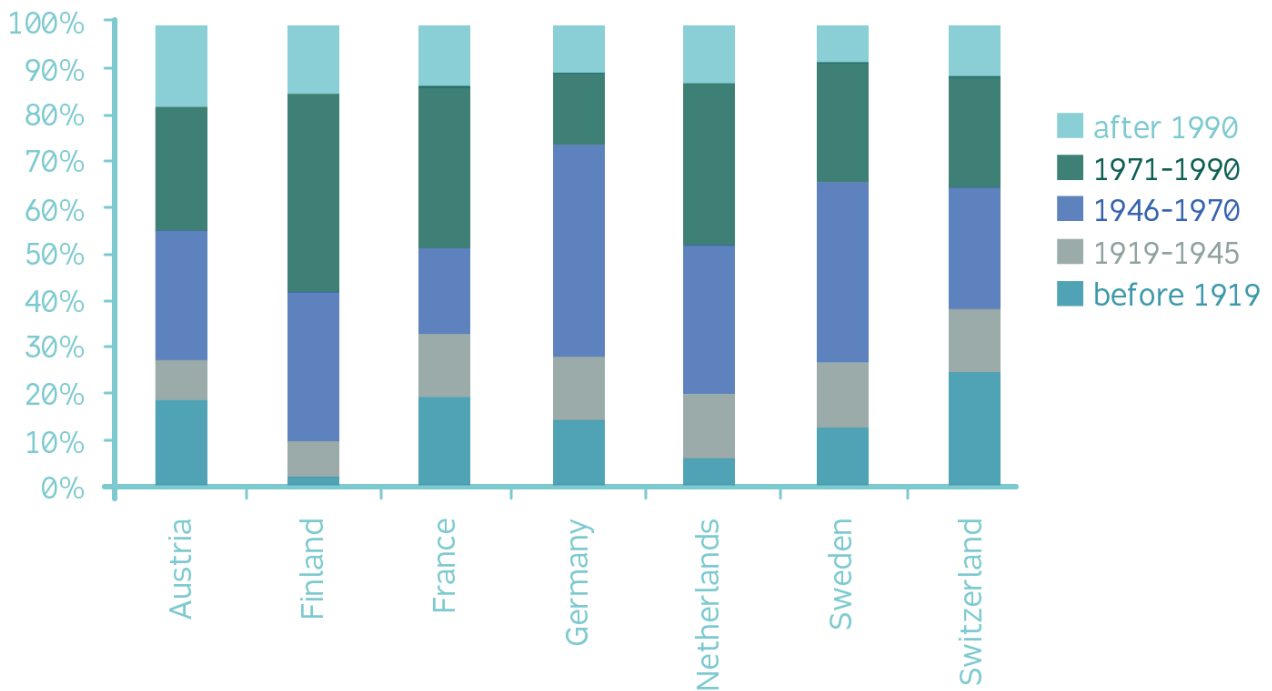

Graph 2.1 Age of dwellings in Northern Europe (source: author)

In the European Union existing buildings are responsible for 30% of the CO<sub>2</sub> emissions and because of their life cycle, they will represent the dominant part of the housing stock for the next 50 years. What is more, they account for around 40% of total final energy use. Because of these reasons it is important to reduce the use of energy in the buildings and increase the use of energy from renewable sources in order to reduce European Union's dependency from fossil fuels energy imports that cause greenhouse gas emissions.

The energy renovation of the existing buildings is the key to achieve sustainability goals, not only in Europe but all over the world. Since the building sector, for what concerns new constructions, is temporarily stationary due to the crisis, the solution is to work on the existing cities and to renovate them starting from the housing sector, the most responsible for fuel consumption. In addition, the lack of permeable soil due to the over occupation of land is another issue related to the sustainability of the anthropic context in which we live, as it contributes to flooding and unbalance of the cities' microclimate.

According to the Life Cycle Assessment method, used to evaluate the environmental impact of a product depending on its entire life, from the extraction of raw materials to the discard of them, it has been calculated that the energy and materials required for a transformation of a building are widely less than those needed for a demolition and new construction. (Graph 2.1)

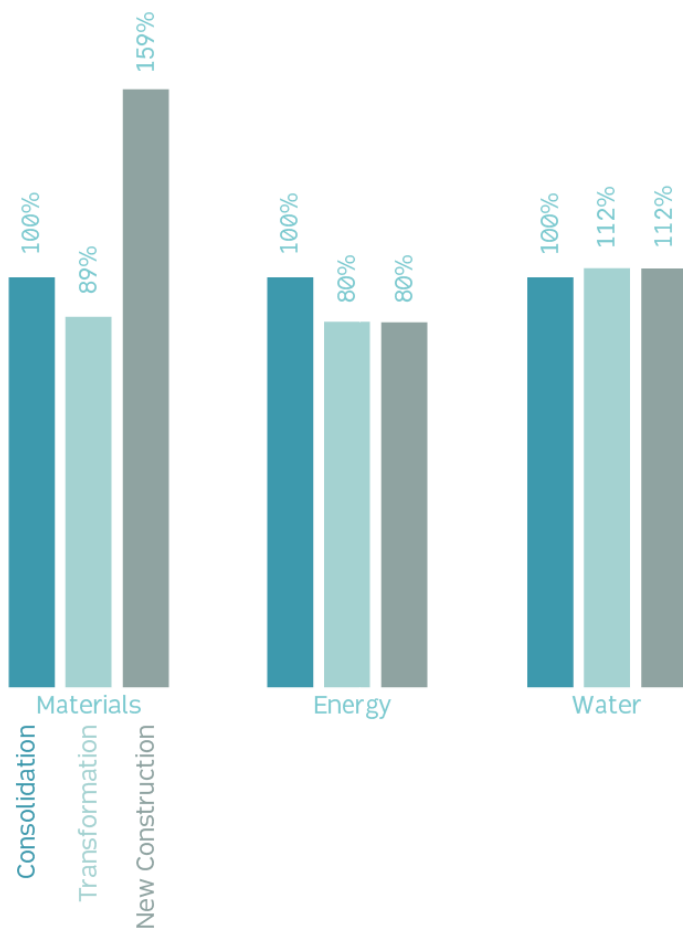

Graph 2.2 Flows of materials, energy and water of consolidation, transformation and new construction (source: author)



Figure 2.1 Building in the district of Kypseli, Athens (source: google images)

The building sector, is one of the milestones of the European Union's economy. This sector is also known for its lack of attraction towards investments, and because of this, only by increasing the size of the energy renovation market it would be possible to have more expenditures in research, innovation and modernisation of the segment.

One of the most popular suggestions in this last years, is the creation of an industrialised mechanism connected to the energy retrofitting of the buildings, in order to improve the feasibility of the interventions, making them more affordable and simple by a standardisation of the process. This would require the creation of an EU energy renovation industry that could unleash the 4<sup>th</sup> industrial revolution in Europe.

The conversion of the EU building stock from being an energy waster to being energy efficient and energy producer, would make citizens active “prosumers” (professional-consumer) and increase equality between them. This would lead to a sustainable economic recovery and ensure a healthy infrastructure for future generations.

## 2.4 The existing housing stock in the Netherlands

In the Netherlands the construction of residential buildings increased after the end of the WW I. For what concerns the type of external walls, the buildings constructed after 1925 were mainly made of brick cavity walls in order to improve moisture protection. Concrete elements were introduced in 1966. Moreover, from 1970 dwellings are composed by thick facades and concrete-brick construction walls. For what concerns the floors, the pre-war ones are mainly made of wood, while from 1970, concrete began to be used. Moreover, until 1970 roofs were made of beams and planking and only after, concrete tile roofs were implemented. About glass systems, the double glass was introduced in new dwellings from 1980. Before 1976, wood and sometimes steel were used for the windows’ frames, while, after 1976, PVC, aluminium or wood were implemented. (Klunder, 2005)



*Figure 2.2 1967 Residential building in Scheveningen, The Hague (source: author)*

## 2.5 European policies

In 1992, during the Rio de Janeiro’s Earth Summit, the UNFCCC (United Nations Framework Convention on Climate Change) was elaborated by 192 member states, including the EU. They met again in 1997 to sign the Kyoto Protocol, an international treaty to reduce GHG emissions. The document stated that the production of pollution elements had to be reduced at least at 8.65% in relation to the 1985 levels.

In 2002, the EU approved the first EPBD, Energy Performance of Buildings Directive, that proposed energy certifications, stimulating the Member States to apply several energy



measures. In particular, the goal was to reduce the European energy consumption of 22% before 2010 and a reduction of the CO<sub>2</sub> production of 100 millions of tons.

The European Energy Performance of Buildings Directive (2008), specifies that when a dwelling is constructed, rented or sold, it needs a certification that states its energy performance, CO<sub>2</sub> emissions and advices for energy performance improvements. The calculations needed take into account different characteristics: thermal characteristics, heat and hot water systems, location and orientation, ventilation, air conditioning and indoor climate. In 2009, the EU created the Renewable Energy Directive RED, to ensure the renewables target will be met. After that, based on the data provided by EUROSTAT (the European statistics service), the share of renewables increased from 12.35% to 15.96%, respectively in 2009 and 2014.

In 2010, the EU approved another EPBD, stating that by the end of 2020, all new buildings should be nearly zero-energy, while all new public buildings should achieve this by 2018.

The energy mix of the building sector is composed by: electricity (33.8%), gas (33%), oil (12%), renewables (11%) and heat (7.31%); in the last years the gross final electricity production was characterised by an increased share of renewables and this states that already renewables represent an important share of buildings' energy consumption. (Laurent, 2013)

Later, the EU approved the Europe 2020, the ten-year growth strategy in which one of the 5 targets to achieve concerns climate change and energy sustainability. It was put into effect through the 2009 climate and energy package and the 2012 Energy Efficiency Directive (EED). It states that, within year 2020:

- Greenhouse gas emissions have to be reduced by 20% than the values of 1990,
- The use of renewable energies has to be increased with a rate of 20%,
- Energy efficiency has to be increased with a rate of 20%.

The second meeting of the UNFCCC member parties took place in Doha, Qatar, in 2012, but unfortunately, the most involved member states, as Russian Federation and Canada, did not submit the target planned for the second commitment period, 2013-2020 (20% reduction of gas emissions).

In October 2014, the European Council signed an agreement on the climate and energy policy structure and endorsed targets for 2030, this foresees:

- A target of 40% GHG emissions reduction compared to 1990 levels,
- A target of at least a 27% share of renewables in total final energy consumption for 2030,
- A target of at least 27% energy savings of primary energy consumption compared to 2007 projections.

Actually, there are three different scenarios elaborated by the EU, the EE27 and the EE30 are related to the 2030 climate objective to reduce GHG emissions by 40% as compared to the 1990 levels, while the EE40 scenario would lead to 44% of reduction and 40% of energy saving. In order to achieve business leaders' confidence to invest in energy renovation, it is necessary to create a stable framework that foresees a sufficient volume of buildings to be renovated every year. Because of this, the 40% energy savings target could drive the large-scale renovation projects needed to gain private investments in energy renovation. It is expected

that the building stock will lead the decarbonisation of the EU energy system and, compared to 2005 levels, GHG emissions are planned to fall by 33.8% in the residential sector and by 50.5% in non-residential buildings, considering the 27% energy savings target by 2030. (EE30 scenario). It seems that EU is on track to meet its 2020 goals in emissions' reduction , but the 40% energy saving target seems unlikely to be met without additional measures.

In order to control the diligence of EU Member States, it was created a Regulation (No 525/2013) about a mechanism for monitoring and reporting GHG emissions. It divides the building sector in other two sub-sectors, on the one hand the households and on the other hand the commercial and institutional. For what concerns the households, they are characterised by the specific CO<sub>2</sub> emissions, calculated as a ratio between CO<sub>2</sub> emissions from fossil fuel consumption and the stock of permanently occupied dwellings.

Later, in December 2015, 174 countries (Russian Federation and Canada included also with the participation of the United States) agreed to the Paris Climate Agreement in order to hold the increase in the global average temperature to below 2°C and to pursue efforts to limit temperature increase to 1.5°C. In 2016 the EC has been undertaking a review of EU legislation related to these climate and energy policies.

The possibility for the EU building stock to become energy efficient and an energy producer leading to net zero energy consumption, could enable it to play a positive and imperative role in the EU energy system. The more energy efficient the EU building stock will be, the more important the energy savings and renewables would be in the EU energy mix and as a consequence the role of buildings in the EU energy system.

In these latest years, the main concern about the energy retrofiting of the buildings was to improve the layering of the existing walls in order to reduce the energy losses during the winter period. Nevertheless, for what concerns the construction of new buildings, attention must be paid during the design process in order to avoid the overheating effect during the summer period. The issue was introduced for the first time in the 2010 EPBD (2010/31/EU).

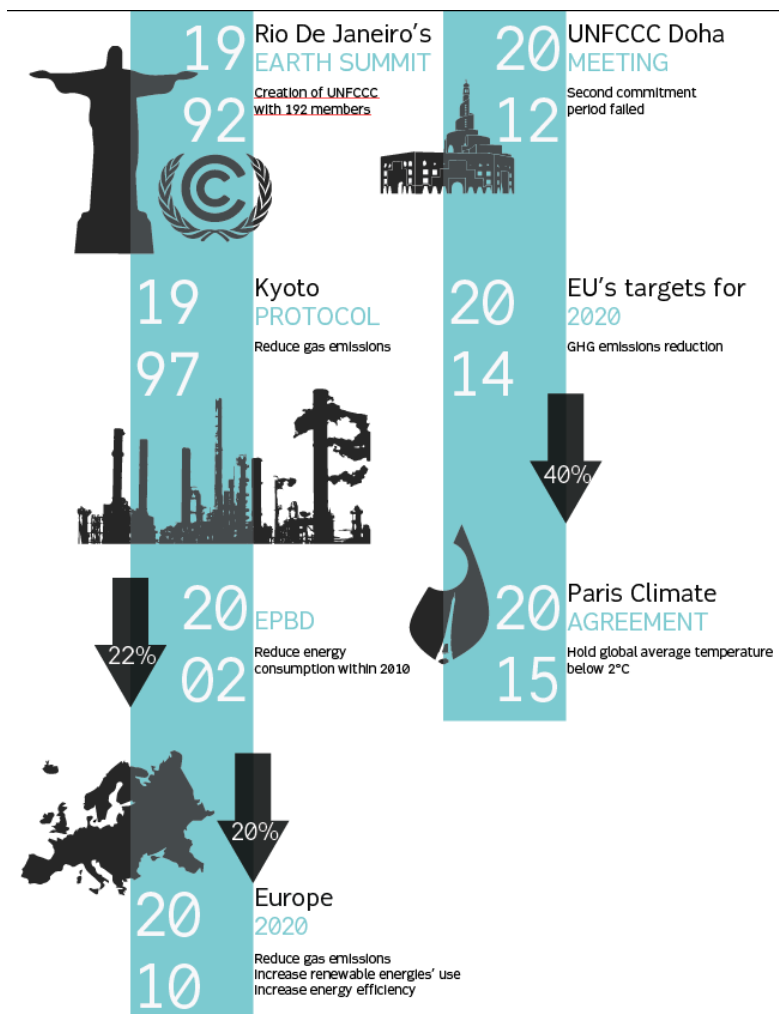

Figure 2.3 Brief timeline of European energy policies (source: author)

### 2.5.1 Definition of energy renovation in EU legislation

The EED, the Directive on energy efficiency (2012/27/EU), explained the concepts of deep renovation, cost-effective deep renovation, substantial and comprehensive refurbishment, while the 2010 EPBD (2010/31/EU), introduced the concept of major renovation. The definition of *Deep Renovation* is described as follows in the EED: “cost-effective deep renovations which lead to a refurbishment that reduces both the delivered and the final energy consumption of a building by a significant percentage compared with the pre-renovation levels leading to a very high energy performance..” . For what concerns the definition of *Substantial Refurbishment*, it is defined as a “refurbishment whose cost exceeds 50% of the investment cost for a new comparable unit”. Furthermore, for what concerns the *Comprehensive Refurbishment*, it has to be considered “the building as a whole, including the building envelope, equipment, operation and maintenance”. For what concerns the term *significant percentage*, it is required an improvement of at least 75% after the building has been renovated.

In the EPBD (Energy Performance of Buildings Directive, 2002), a major renovation is defined as a renovation of a part of the building that will achieve the same energy performance targets as new buildings:

- The total cost of the renovation relating to the building envelope or the technical building systems is higher than 25% of the value of the building, excluding the value of the land upon which the building is situated; or
- More than 25% of the surface of the building envelope undergoes renovation.

Later, it has been stated that, according to guidelines published by the European Commission in 2014, there are three types of energy renovations: the implementation of single measures, the combination of single measures (standard renovation) and the deep or major energy renovation.

## 2.6 The Dutch policies

### 2.6.1 Introduction

The concept that environmental impact of the buildings has to be quantified and calculated, finds its roots in a manner of thinking related to the 'Factor 20'. This was a theory elaborated by Commoner (1971) and later completed by Ehrlich and Ehrlich (1990). The former thought that the global environmental impact depends on the population size, the average prosperity per person and the environmental impact per unit of prosperity. The latter put this statements in a formula:

$$I_t = P_o \times P_r \times I_p$$

Where:

$I_t$  = global environmental impact

$P_o$  = population size

$P_r$  = average prosperity per person

$I_p$  = environmental impact per unit of prosperity

So if, for example, a halving of the global environmental impact is required for the period from 1990 to 2040, a doubling of the population is considered and average prosperity 5 times higher than in 1990. Consequently, it is needed to reduce the environmental impact per unit of prosperity by a factor of 20. This is equal to a reduction of the environmental impact by 95%. This statement is helpful in order to understand the importance of thinking in factors and look for quantitative information, rather than using a more intuitive approach without exact results. This is a well-known slogan in Dutch Science and Policy in terms of sustainability for the built environment.

### 2.6.2 Energy labels

In 1995 the Netherlands created a list of energy labels for houses, described by the Energy Performance Advice (EPA), that were later on substituted by the 2006 regulation.

In 2008 the Netherlands put into effect the EU Energy Performance of Building Directive (EPBD) that established minimum energy performance requirements for new and existing buildings, assured the certification of building performance and required the regular inspection of boilers and air-conditioning systems in buildings. For what concerned the new buildings it included the aims of achieving a Nearly Zero Energy Buildings standard for 2020. In order to put into effect this directive, earlier in 2006, the Dutch government published a Decree (BEG) and a Regulation (REG) on the energy performance of buildings followed up by the definition of the calculation for the energy performance of residential buildings 'ISSO82'. Further, a

definition for large-scale renovations, related to the nZEB, is intended to be explained in the Building Decree Regulation. The Dutch Standardisation Institute and the Dutch Building Services Knowledge Centre describe the calculation for the Energy Index EI as follows:

$$EI = \frac{Q_{total}}{(155 \times A_{floor} + 106 \times A_{loss} + 9560)}$$

This index is a value ranging from 0 (extremely good performance) to 4 (extremely bad performance). These values are categorised in order to make the owners aware of the thermal quality of their dwellings. (Table 2.1)

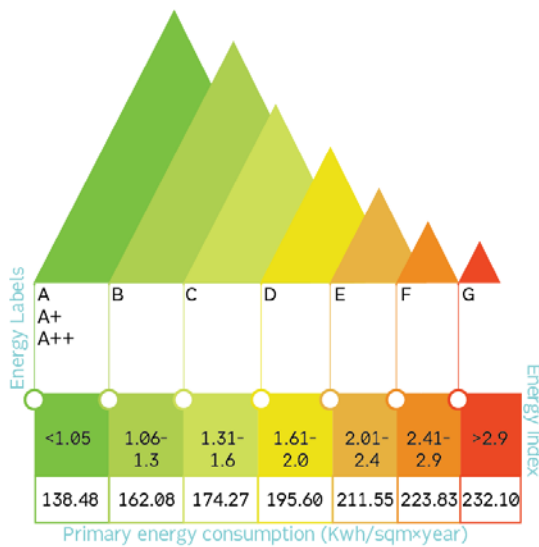

Table 2.1 Different Energy labels and Indexes depending on different Primary Energy Consumption, valid until 2014 (source: author)

$Q_{total}$  refers to the theoretical yearly primary energy use of a dwelling, while the corrections in the denominator include:  $A_{floor}$  that refers to the total heated floor area of the dwelling and  $A_{loss}$  that refers to the areas that are not heated in the dwelling.

Since the 2015 the method to calculate the EI changed and is now based on a point system that allocate a score of points to each dwelling that correspond to an energy label after the registration to the Netherlands Enterprise Agency(RVO).

In a study on the effect of the Dutch Energy Performance Coefficient (EPC) values about new dwellings, it has been found that the energy demand is influenced primarily by the building envelope and the type of dwelling but also occupant habits and behaviour significantly affect energy use (4.2% of the variation in energy use for heating).

The Netherlands are deeply involved in trying to achieve energy retrofitting goals, and because of that, Dutch legislation allows landlords to include retrofitting costs in the rents. Furthermore, the Netherlands, are one the countries that foresee penalties in case of non compliances with energy performance requirements. What is more, regional and local regulations establish a minimum threshold for the mandatory communication of changes in energy performance in the buildings. Finally, the Dutch government has also provided grants for demonstration projects for nearly zero-energy buildings.

In September 2013 the Dutch government concluded the Energy Agreement (Energieakkoord) for sustainable growth. The goal is to bring the yearly energy efficiency improvement until 2020 at a level of 1.5 % per year. Regarding dwellings, 400 million euro of subsidies have been fixed to stimulate investments for savings with social housing corporations.

Moreover, it has been seen that energy efficient office buildings are characterised by higher rents than less efficient ones. This seems to be a positive signal, that something in the real estate market is changing and, maybe, the conditions for an energy redevelopment market are slowly being built on.

### 2.6.3 Energiesprong

Energiesprong is a Dutch program that has developed energy renovation kits for the social housing stock built between 1950 and 1970 in the Netherlands. The project involves several actors, Energiesprong plays the role of an Energy Renovation Facilitator, as it succeeded in bringing together different stakeholders as the Social Housing Associations with private housing and commercial property sectors. The Social Housing Associations are widely involved in this process as they take the financial risk because of the bank's loan, they invest in the energy refurbishment of the houses and they receive the rent and energy bills paid by the tenants until the loan is repaid. Moreover, there is a private company that has the assignment to rate the projects submitted by energy renovation companies as these latter have to guarantee: a 3-day delivery timetable, aesthetic attractiveness of the project and a 30-years insurance-backed energy performance. For what concerns the intervention, the changes interest the roof, the floor, the heating plant, the façade and the walls' insulation. Till now it has been possible to operate on at most 3-4 floors buildings. The process is characterised by the use of prefabricated components and the heating plant is always put outside the house in order to gain internal space and avoid annoying noises. The principal aim is to try to sell to people something they have never been interested to, in other terms, try to create a business model as there is still very little demand for nZEBs. However, for private owners it has been stated that other 3 years, at least, are needed in order to set up the conditions for them to invest in such interventions. What is more, till now this approach has been operated only on Dutch typical homes, but in order to apply it on other realities it will be necessary to find different solutions and adapt the market transition model. Finally, this method does not foresee a free field of action for the architect, as it is basically based on prefabrication and industrialisation models, that for their nature do not take into account a free architectural composition approach. (Figure 2.3)

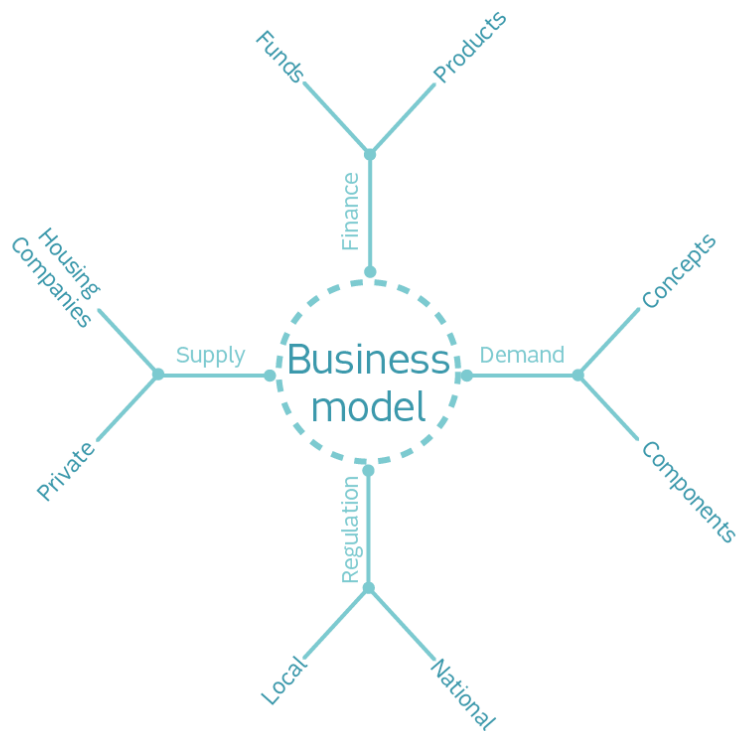

Figure 2.4 Energiesprong's business model (source: author)



Figure 2.5 Oud-Vossemeer, example of Energiesprong's work (source: [www.energiesprong.nl](http://www.energiesprong.nl))

#### 2.6.4 The non-profit housing sector

The European Social Housing Organisations (SHO) are dealing with the economic crisis that has affected both their finances and the finances of their tenants. This represents an obstacle to the housing renovation projects and application of energy efficiency measures. Currently, SHOs own around 9.4% of the total housing stock in Europe and only in Austria and Netherlands SHOs' ownership represent more than 20% of the total housing stock.

In the Netherlands non-profit housing associations own the 31% of the total housing market, that is the highest percentage in Europe and they are considered autonomous and self-financing organisations since 1995 because they do not receive any subsidies from the national government. Since the maintenance of the dwellings is one of their main concerns, the sustainability and energy savings issues play a role in their choices. Moreover the non-profit housing sector has a collective nature and central way of policy and decision making that could make it an example in terms of energy efficiency goals. This approach has been encouraged also by the increase of the European awareness in this field that has led to the creation of the Energy Saving Covenant for the Rental Sector in 2012, which main purpose is to achieve an average EI of 1.25 by the end of 2020 (label B) for the Dutch social housing sector. This Covenant was signed by Aedes (Dutch association for housing organisations), Woonbond (Dutch tenants' union), Vastgoed Belang (Dutch association of real estate investors) and the national government, and it leads to the introduction of the energy labels as one of the parameters of the regulated rents in social housing. Part of the Energy Covenant was the *total housing costs guarantee* that ensured tenants that rent increases, needed for the investments in energy efficiency measures, would be balanced by decreased housing costs due to the energy savings.

Unfortunately it has been found that the the pace of change is too slow to reach the 2020 energy efficiency purpose. Because of this, in 2008, Aedes started a monitoring system, called SHAERE, that is the official tool for monitoring the progress in the field of energy saving measures for the social housing sector. Thanks to this implement it is now clear that, the more the energy efficient solutions applied, the more the impact is on the EI. In addition it has been noticed that there is a tendency for conventional rather than innovative maintenance measures; furthermore when energy improvements do take place, usually only one or two measures are carried on per dwelling. Finally it is revealed that when municipal support is offered, it results in more concrete energy renovation plans. (Filippidou, 2016)

More specifically, it has been conducted a survey about the actual measures applied between 2010 and 2013. It has been found out that the tendency was to change the conventional boilers ( $\eta < 0.8$ ) into condensing high efficiency ones. Generally the change into more sustainable plants as heat pumps was not so common and the substitution of the heating plants, within the energy efficiency measures applied, was one of the most applied with a total percentage of 17.6%. For what concerns the domestic hot water system, a total percentage of 15.5% was the change from tankless gas water heaters into high efficiency combi-boilers to a  $\mu$ CHP system. It has been also verified that there was a change from heat pumps into condensing high efficiency boilers, probably because of the slowness in generating hot water. Going forward, the change of the ventilation system had a percentage of 8.7%. One of the most popular energy saving measures was the change of the type of windows with a percentage of 10%, and it was revealed that the change into more ambitious energy efficiency measures, such as a triple insulation glass, was a rarity. In general, this type of intervention was more common in the non-profit housing sector due to the fact that old uninsulated windows were being replaced on a national scale. About the change for wall insulation, it has been calculated as a 7.06% of the total measures, underlining that the majority of the non-profit building stock had been built before the 1970<sub>s</sub> without wall insulation. Finally, the change in roof and floor insulation were respectively 6.64% and 9.42% of the total modifications. In conclusion, analysing the 2010-2013 range of years, it has been noticed that 64.5% of dwellings had no



change, while for the rest 35.5%, the majority of them had one measure performed and only the 3% had more than three measures implemented. (Filippidou, 2016) (Figure 2.4 and 2.5)



Figure 2.6 Percentage of dwellings with energy efficiency measures applied and not (source: author)

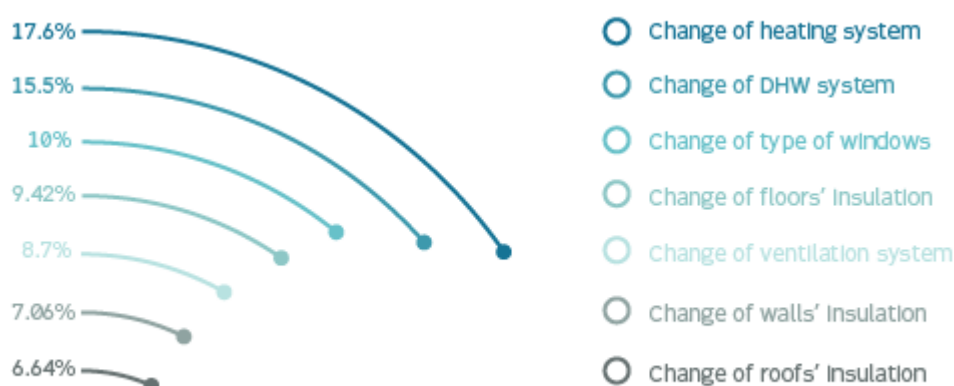

Figure 2.7 Percentages of energy efficiency measures applied (source: author)

### 2.6.5 The private sector

Within the private housing sector, a division must be made between owner-occupied and private rented. In the first case the investor and the one who gains from the investment are the same figure, and because of this, it is common a lack of financial means to invest. While for the private rented sector, even if the one who profits from the investment is the occupant and not the owner, this may be solved by increasing the rent in order to repay the owner's investment, whenever this is possible. Moreover, owner-occupiers' barrier to the application of energy efficiency measures is the lack of knowledge and information, as these questions are not significant issues for them.

The number of homeowners that possess an EPC when selling a house is very low. More specifically, there are 2.1 million EPCs logged, but only 10% of these are for private dwellings,

while the remaining are for rented social housing. In fact, the theoretical calculated energy consumption obtained with the EPC does not represent the actual consumption of a dwelling and one of the causes is that it does not take into account the potential variations in occupants' behaviours.

### 3 The energy demand of the heating system

In order to calculate the Thermal Balance of a building it is important to consider both Dispersions and Gains. The former take place through the shell and the openings (windows, doors), while the latter are referred to Solar or Internal Gains:

$$\text{Dispersions} - \text{Gains} = \text{Total Primary Energy Demand}$$

Generally the Energy Index EI of a building is calculated as a ratio between the Energy Demand and the Useful Computation Surface:

$$\text{EI Energy Index} = \frac{Q \text{ Total Primary Energy Demand}}{A \text{ Useful Computation Surface}}$$

It is well verified that there is a wide gap between normative theoretical calculations made following the Energy Performance Certificate (EPC) approach and real energy consumption evaluated on the base of what the tenant pays at the end of the month. Not only, also the energy savings evaluated, after the energy efficiency measures to be applied, are obtained with the use of a theoretical approach that doesn't always reflect the real expectations. For what concerns the Netherlands, it has been elaborated a research in order to quantify this gap and understand the reasons of it. Based on The WoON 2006 survey, conducted by the Dutch Ministry of Housing, Spatial Planning and the Environment, containing information for more than 4,700 Dutch households, the study has compared the real energy consumption of the dwellings, based on energy bill data, with the theoretical one and has used the *Heating Factor* as score. It is the ratio between the real energy demand and the calculated one. A *Heating Factor* of 1 means that the theoretical energy demand is equal to the real one, while a *Heating Factor* higher than 1 means that the real consumption is higher than expected, and the opposite situation happens for a *Heating Factor* lower than 1. The results show that there is a consistent over prediction in space heating energy use and in many cases this is due to the fact that EPC refers to well heated properties, which several are not. What is more, the lower the energy efficiency of the housing is, the higher the overestimation of the consumption is. This over estimation is also known as the "prebound effect". There are some possible causes to this wrong evaluation: the simplicity of the models, the uncertainty in technical and climatic model data inputs, the uncertainty in the measurement of domestic energy consumption and behavioural issues. Moreover, there is also another effect due to the uncertainty of this method, that is the so called "rebound effect", related to the overestimation of energy savings after the energy efficiency measures to be applied. Generally this is caused by a change of tenants' behaviour of increasing the level of their thermal comfort after retrofitting.

In order to quantify the gap between the predicted energy savings and the real ones, the so called "intensity curves" can be used, as they relate the Theoretical Heating Cost to Intensity of Use, since it has been discovered that the former influences the latter and more specifically, the lower the theoretical cost, the higher the intensity of use by the households. (Figure 3.1)

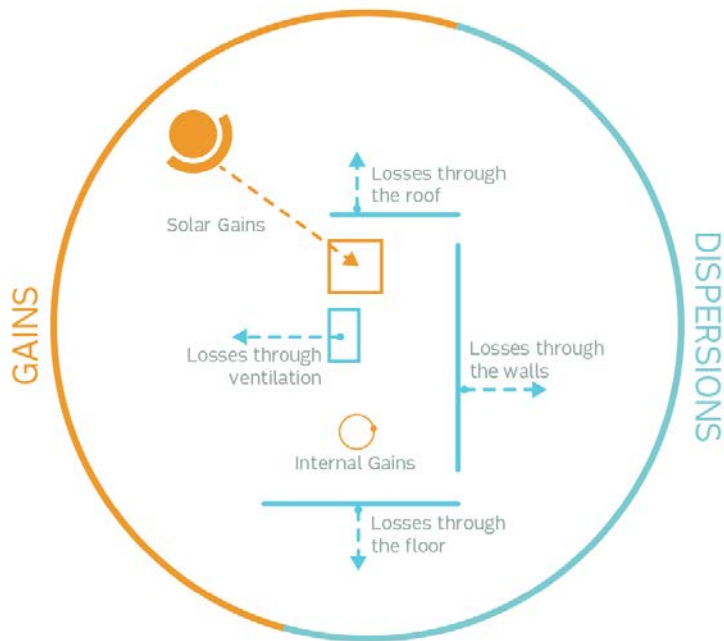

Figure 3.1 Energy Gains and Dispersions scheme for a house (source: author)

## 4 Add-ons as a strategy

### 4.1 Introduction

A strategy needs to be elaborated in order to let the energy refurbishment of buildings become a common practice all over Europe. The add-ons option gives the possibility to overcome the economic obstacle represented by the lack of interest in investing on dwellings' energy retrofiting. What have to be stated are the conditions that could effectively allow the feasibility of these interventions and, although each building has its own characteristics and needs, only by experimenting this process it could be stated whether this approach could be successful or not.

### 4.2 The strategy

As the main obstacle to energy redevelopment interventions is the economic factor, the first step to be done in order to prepare the field of action for the investment is towards the feasibility of it. Why private or public owners should spend money to apply energy saving measures on their properties? The actual environmental awareness is an important issue but certainly is not regarded as a fruitful moneybox to put savings yet. This is the main issue. The energy renovation intervention needs to be matched with something that could, at the same time, make it possible and attractive. What is more, as the context is the real estate market, only economic actions made on the properties could satisfy the requests. As a consequence, the answer is easy to be obtained: new floor area means possibility to sell. Selling new properties implicates gaining money that could be partly invested in energy saving measures on the existing constructions. More specifically, this theory is put into effect by the addition of new volumes to the existing buildings; these volumes have a high economic value as they are nZEB, satisfying the latest regulations on sustainable constructions. Sometimes the modifications on the existing are so considerable that a new detached building is needed in

order to repay the investment, the *Assistant Building*, and if possible, making it the renewable energy distributor for the surrounding existing buildings.

### 4.3 ABRACADABRA Project

ABRACADABRA is the acronym of a title that explains the project's strategy:

Assistant Buildings' addition to Retrofit, Adopt, Cure And Develop the Actual Buildings up to zeRo energy, Activating a market for deep renovation.

It has received funds from the European Union's Horizon 2020 Research and Innovation program. This latter has nearly €80 billion funding available over 7 years (2014-2020) and its aim is to stimulate discoveries and ideas to be inserted in the market.

ABRACADABRA is based on the assumption that transformations and adaptations on the existing buildings must be accompanied by the creation of new useful floor areas in order to counterbalance the economic investments for energy saving measures. The goal is to state new tools, concerning the market, the policies and the social context, in order to make this approach feasible. The objective is to create a concrete real estate market characterized by the Nearly Zero Energy Buildings target.

As a consequence, ABRA focuses on demonstrating to stakeholders and financial investors the attractiveness of a new renovation method also based on AdoRe, that is one or more Assistant Building unit(s), like aside or façade additions, rooftop extensions or even a new building construction – that adopts the existing buildings (the Assisted Buildings).

## 5 Examples

### 5.1 Introduction

In this chapter, three already completed add-ons examples are presented and analysed. The sources of information were, not only the websites of the architects' studios, but also their presentations in occasion of the 24<sup>th</sup> of June ABRACADABRA Kick-off meeting that took place in Bologna in 2016. In addition, a proposal project by three students of the University of Bologna is presented as an example of add-ons on Italian social housing buildings. The goal of this chapter is to evaluate some of the best practices in the field of energy refurbishment of dwellings in order to show the feasibility of this practice and highlight the conditions in which the building processes occurred.

### 5.2 The Himmerland Housing Association, Departments 19 & 22

The Himmerland Housing Association owns the 1977 prefabricated dwellings estate composed by 370 homes. These have been converted and renovated into a sustainable garden city complex by the architects' studio between 2009 and 2016. Light has been added to the existing by the construction of large windows, French balconies and bay windows. Some houses have been combined into larger flats, while others are being expanded with rooftop additions of open spaces combined with full-height glazing. The new cladding is a timber façade which, as well as the rooftop flats, are designed as prefabricated units hosted in place. As a result, the constructions now meet the strict requirements of the Danish low-energy class 2020. The departments 19 & 22 were typical examples of public housing dating from 1970s. The unwelcoming appearance of the small windows and monotonous and dilapidated concrete facades also showed heat loss in critical areas. Thanks to conversions and extensions, new housing types have been introduced that were not previously present among

the flats in these two sections of the housing association in order to bring a wider diversity of residents. The project is based on a sustainability strategy applied with low maintenance costs and all energy savings achieved only by means of passive measures. Sustainable urban drainage systems and permeable surfaces were created, besides a wetland with rain beds to handle precipitation and collect rainwater.

-  Daylight
-  Low energy windows
-  Sustainable planning
-  Prefabricated components
-  Energy renovation
-  Low energy standard (2020)



Figure 5.1 Sustainable precautions and pictures of the construction phases (source graphics: author, source pictures: [www.cfmoller.com](http://www.cfmoller.com))

### 5.3 The 'Bois Le Prêtre' tower metamorphosis

The 100 residences of the building situated in 5 Boulevard du Bois Le Prêtre (Paris 17ème) have been radically transformed in their conditions of comfort and habitability. The tower was built in 1962 by the architect Raymond Lopez, it is 50 meters high with 16 levels serving each one 4 or 8 residences. With the addition of winter-gardens and balconies the surface has been carried from 8,900 sqm to 12,460 sqm. Winter-gardens are closed balconies surrounded by glass in order to receive sunlight during the day. Mainly by the addition of the winter-gardens, the energy consumption has been decreased of at least 50%, and thanks to this, the rental offer has remained the same. In fact, even if the energy demand has been decreased, the rents have been fixed at the same original values in order to finance the building process.

More specifically, the existing structures have been preserved and by opening the bays, the prefabricated balconies of three meters depth have been juxtaposed with the existing frontages. The surface of winter-gardens is about 25 sqm for each 42 sqm of existing housing.



-  Daylight
-  Winter-gardens
-  Sustainable planning
-  Prefabricated components
-  Unchanged rents
-  Low energy standard (2020)



Figure 5.2 Sustainable precautions and pictures of the construction phases (source graphics: author, source pictures: [www.druot.net](http://www.druot.net))

## 5.4 The Giesshübel pile up

The Giesshübel pile up in Zürich, or the urban densification in wood as the architects call it, consists of a rooftop addition of four floors of apartments on an ancient storage building and the renovation of the existing complex hosting the SZU Headquarters at the ground floor. Different timber prefabricated walls have been used with different dimensions of 5x2.7 m, 4.7x3.1 m, 5.1x3.1 m and 8.7x2.9 m. In order to set up the prefabricated floors and walls, the concrete lift and stairs structures have been continued in height over the existing ones.

-  Daylight
-  Low energy windows
-  Sustainable planning
-  Prefabricated components
-  Energy renovation



Figure 5.3 Sustainable precautions, pictures, section and floor plan (source graphics: author, source pictures: [www.burkhalter-sumi.ch](http://www.burkhalter-sumi.ch))

## 5.5 Tower and line social housing blocks in Bologna

The intervention area is located in Bologna, in a suburban site not far from the city center and well connected through the main mobility infrastructures. More specifically, it consists of three tower blocks and a line block along Via Torino, built for social housing in the '70s.

About these topics a detailed executive project on each building has been developed. The energy refurbishment of existing buildings has begun with a check on buildings' thermal behavior in terms of thermal transmittance and renewable energy systems following the recent dispositions about buildings' energy certifications. Moreover, the above mentioned check has been accompanied, not only by volumetric additions on them, but also by the creation of new assistant buildings in order to provide a profitable investment for the intervention. The cost-benefit analysis has represented the essential stage of this process. In fact, in order to achieve an energy renovation an economic investment is needed. Not only the annual energy consumption of the buildings has been converted into an annual saving, but also the market value of them has increased thanks to the overall improvements. For a total useful floor area of 25.500 sqm, the remaining thermal consumption after renovation has been covered by the installation of photovoltaic panels. Different progressive incremental scenarios have been imagined in order to widen the range of action for the intervention. In order to obtain a total balance between costs and benefits, or an immediate return time, it has been required to build around 10.504 sqm of new useful floor area. This intervention provides a tower adhesion combined with a line block adhesion of new housing units and the ground floor saturation of the line block with retail units, the attic saturation of the line block and the cellars saturation in the tower blocks. As a result it gives a small immediate profit of

925.000 euros. In order to obtain a significant profit opportunity 11.664 sqm had to be built for a profit of 2.898.000 euros.

For what concerned the tower block's surfaces there are two types of wall cross sections: the concrete structural part is layered with perforated bricks in the inner part, while the curtain wall was composed by layers of polystyrene, perforated brick and plaster. Furthermore, the floor's cross section is composed by lean concrete subfloor, cork, concrete and plaster. This configuration gives a primary energy demand of 237 kwh/sqm. With the intervention a layer of wood fiber is added to each component to provide insulation and decrease the energy demand of the building. As a result, the primary energy demand reaches the level of 28 kwh/sqm. The line block has a similar configuration to the tower block with an energy demand of 286 kwh/sqm, and after the retrofitting it reaches the level of 21 kwh/sqm. In both cases it has been assumed that the windows' fixtures are replaced with a double glass system.

A prefabricated technology, realized in factory and just assembled on site, has been thought for the new construction process. In order to maximize the transportable dimensions, two units having the same sizes as the shipping containers (20' - 40') have been used. These could be composed together in a plenty of solutions (on one or two floors) and, most of all, able to satisfy the needs of many types of possible users: families, couples or singles. The boxes are made of a steel frame of box sections 20x10 reinforced with angle brackets 80x8. The floor is layered with a floating floor, a wooden planking, a filling of mineral wool and an insulation panel of wood fiber covered by an outer finish. The primary energy index of a housing unit is 18 kwh/sqm.

-  Daylight
-  Low energy windows
-  Sustainable planning
-  Prefabricated components
-  Energy renovation



ADDRESS  
Via Torino, Bologna, Italy  
SIZE  
25,500 m<sup>2</sup> before renovation  
YEAR  
2016

Figure 5.4 Sustainable precautions, renderings and technical detail (source: author)



## B. Scheveningen Case Study

### 6 Analysis of the actual state of the Case Study

#### 6.1 Environmental and physical climatic criticalities

##### 6.1.1 Location

The case study is located near to the port of The Hague and are situated in the district of Scheveningen. The Hague is located in the west part of The Netherlands in South Holland and is part of the Randstad, with Rotterdam, Dordrecht, Leiden and Delft. The construction is composed by some buildings being part of a block surrounded by three roads: Zeesluisweg Road, Westduinweg Road and Schokkerweg Road. The total area of interest of the case study is 2,229 sqm and the constructions being part of it consist of: five neighbouring buildings (block A) and one other detached (block B), all facing a road called Zeesluisweg, and another complex of buildings situated in the inner part of the block, behind those facing the road. The inner buildings will not be evaluated during the SWOT analysis because, following the design decisions, they will be demolished and only the cost for this intervention will be taken into account during the cost- benefit analysis. The buildings are owned by an architecture studio, the Urban Climate Architects. The entire block is directed following approximately an ENE-WSW orientation.

Scheveningen is a seaside resort with a long and sandy beach with a pier and a lighthouse near to The Hague's port that was dug starting from the beginning of 20<sup>th</sup> century and nowadays it can host medium tonnage merchant ships. Moreover, the closest park is the south east located Doornpark, while the bigger Scheveningse Bosjes (Scheveningse Wood) is located in the east part of the district.

The buildings not only host dwellings but also a bar and a kindergarten at the ground floor.

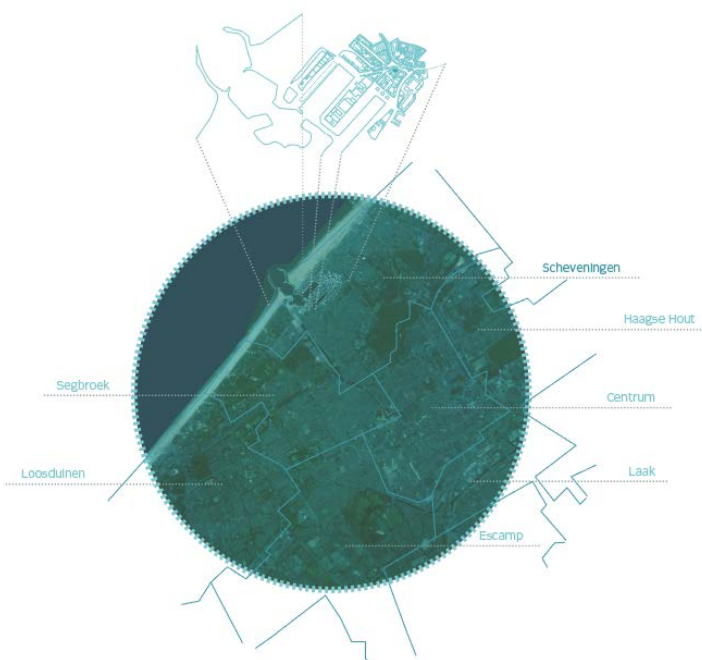

Figure 6.1 Map of The Hague with division of districts and focus on Scheveningen (source: author)

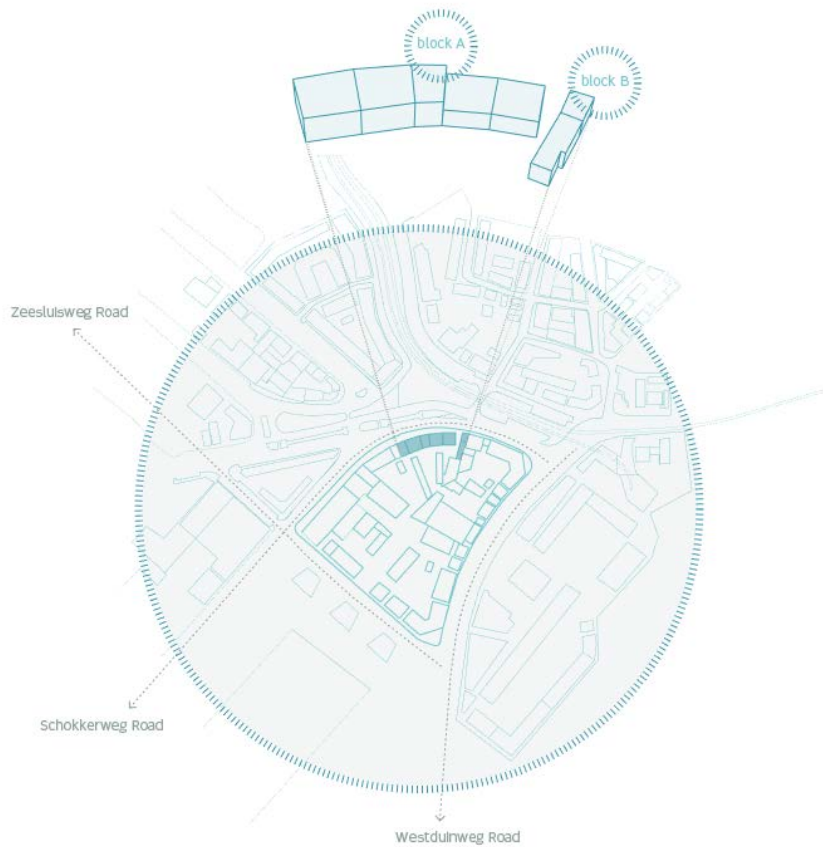

Figure 6.2 Focus on case study buildings (source: author)



Figure 6.3 View of Scheveningen's beach (source: author)

### 6.1.2 Road network and permeability

As Scheveningen is a seaside location, the road connections are usually busy in summer. The nearest parking, in relation to the case study buildings, is located in south west, facing the entrance to the port. In addition, the block is surrounded by cycling lanes and it is served either by tram and bus. Due to the proximity to the sea and the opportunity for air change thanks to the wind flows, the air pollution of the area has a Good mean level (0-50 AQI) relating to the Air Quality Index (data from Rebecquerstraat, The Hague). It takes into account several types of particulate, including the harmful PM10, usually caused by traffic congestion.

As for the permeability of the soil in the surroundings of the case study site, the nearest green spots are located in front of the near 16 floors high building, while the first park, the Doornpark, is located about 1 km far away from the site. The lack of permeable soil in the

neighbourhood is a weakness of the place that is, however, balanced by the closeness to the sea.

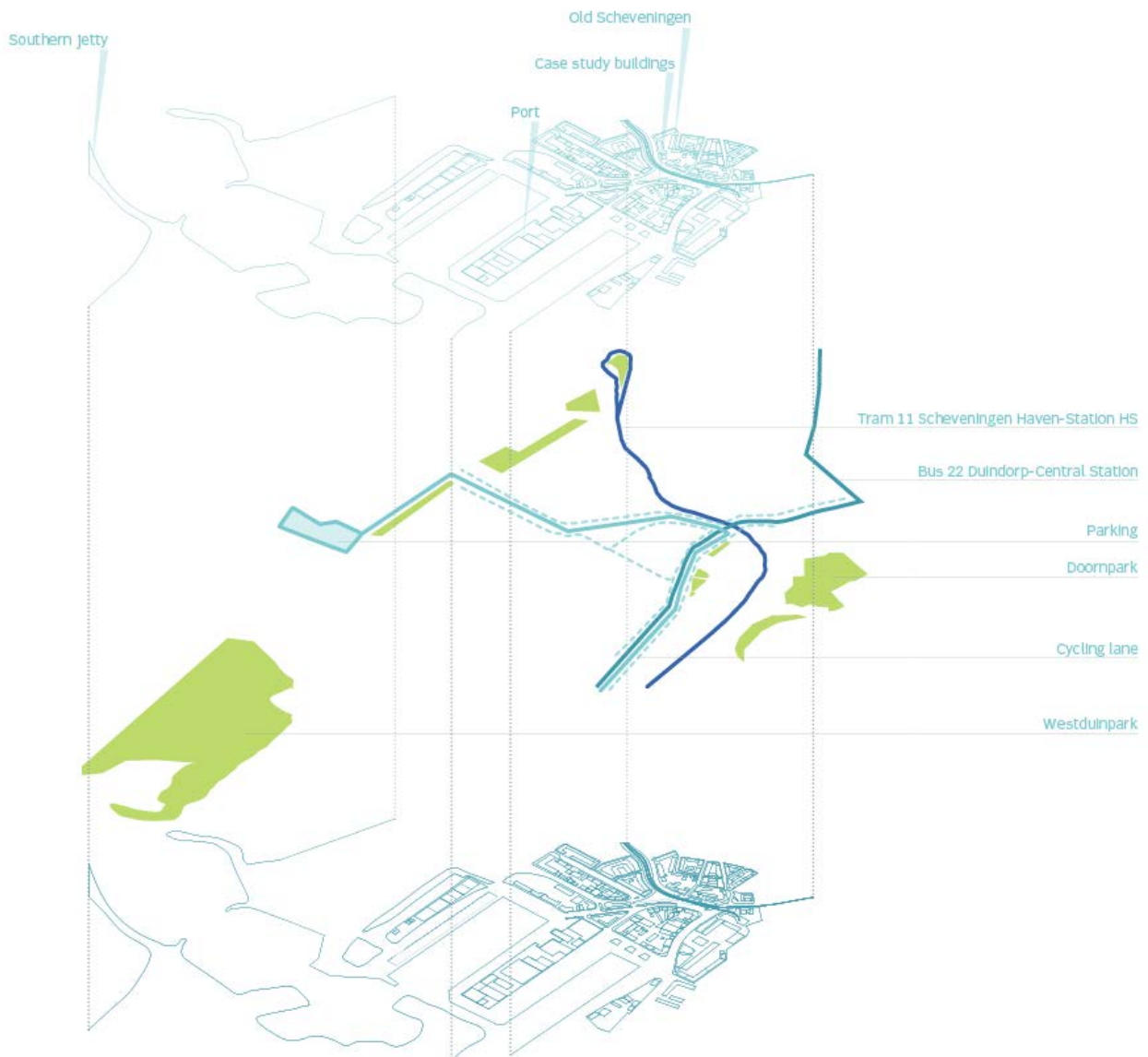

Figure 6.4 Principal transport routes and green areas near the case study buildings (source: author)

### 6.1.3 Sun and temperatures

The principal facades of each building are approximately facing the north and, because of this, they are mainly shaded during the year. Moreover, the closeness to a high 16 floors building situated in the right block next to the case study buildings, determines long lasting shade on them during the winter season, when the sun is low in the sky. In addition, in the afternoon, the higher buildings of the case study block determine shade on the lower ones next to them. Four shadow range periods have been evaluated in order to understand how the shadows move across the site. The first evaluation has been done analysing a shadow range of nine hours during the summer solstice. In this period of the year (summer) the sun reaches the highest elevation in the sky with an inclination of about  $60^\circ$  and consequently the shadows do not have extended shapes. The front sides of the case study buildings are mainly shaded as they are oriented towards north. During spring, as can be seen from the spring equinox graphic, the sun reaches an elevation of about  $40^\circ$  and, because of this, the shadows are more

extended and, concerning the case study buildings, the highest ones determine shadows on the lowest next to them as there is one floor difference. During winter, evaluating a shadow range of seven hours in winter solstice, the sun reaches a maximum elevation of about 15° in the sky and this reflects on the scarce illumination of the facades during the day. Not only the north facades are permanently shaded, but also the other facades and roofs are scarcely illuminated due to the presence of other higher buildings in the surroundings, and above all, two 16 floors buildings situated in the south eastern part of the neighbourhood. Finally, concerning the autumn period, when the sun reaches the highest position at about 40° (as in spring period) in the sky, the highest neighbouring buildings' shades do not reach the case study ones but still the north facades are permanently shaded and the highest buildings of the block cause shade on the others next to them, nevertheless there is no wide difference with the spring period. By crossing the four different shading configurations, it can be stated that the less illuminated facades are the NNW directed ones, those facing the street, while the roofs and the back and lateral facades receive illumination mostly in the afternoon, when the sun rays are not stopped by the presence of higher neighbouring constructions.

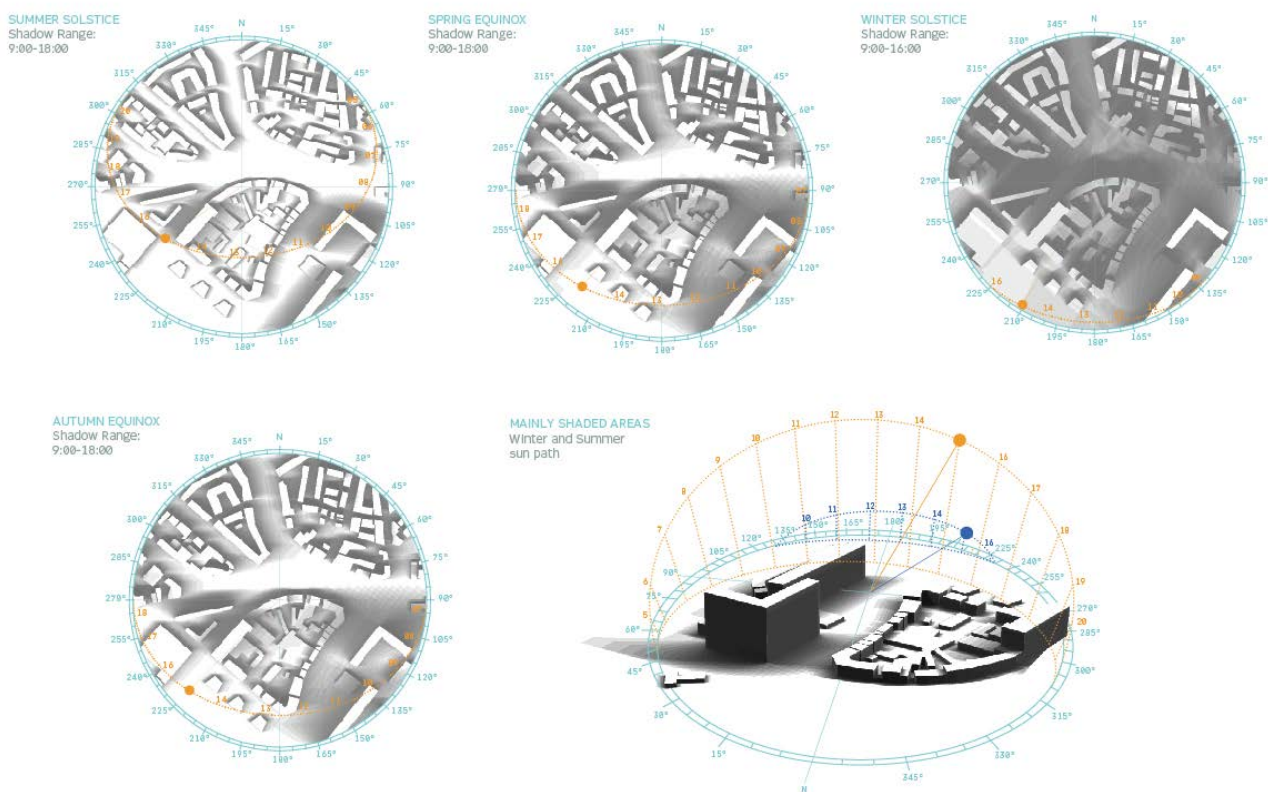
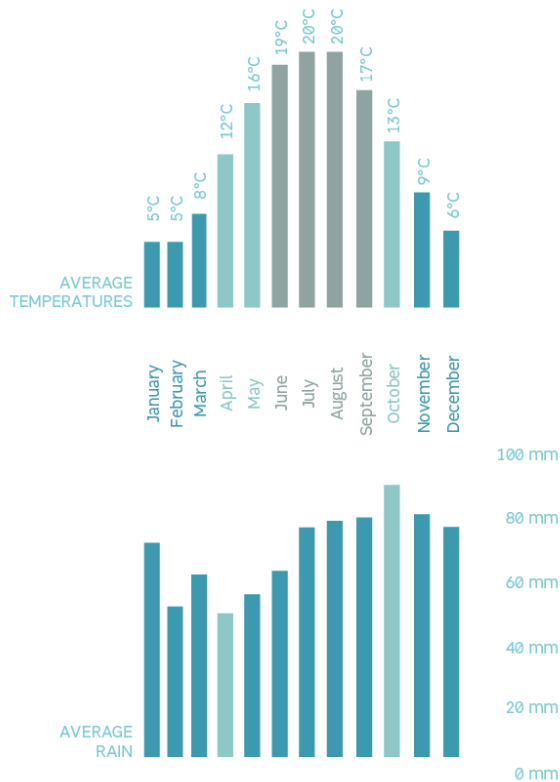

Figure 6.5 Different shading scenarios following the seasons and mainly shaded areas (source: author; software: Autodesk Ecotect Analysis)

Based on data collected by the Rotterdam Airport Meteorological Station during the period November 2001-August 2016, the average temperature in each season can be stated. During the winter season (December-March), the mean value for the temperature is 6°C, while during the summer period (June-September) the mean value is 19°C.

About the rain, April is the less rainy month with an average of 45 mm, while October is the rainiest month with a mean value of 85 mm.



Graph 5.1 Temperatures and rain statistics, Rotterdam Airport Meteorological Station (source: author)

#### 6.1.4 Wind Rose

Following the data collected by the Rotterdam Airport Meteorological Station during the period November 2001-August 2016, it can be evaluated the effect of the wind in the case study location. During winter, from December until February, the predominant wind direction ranges from SSW (202°) to SW (225°). March seems to be the only month in which the wind direction is NE (45°). While in summer, from June till September, it remains stationary from WSW (247°), only in August it changes a little coming mainly from W (270°). Considering the whole year, the average wind direction is WSW with a mean value for its speed of 10 kts and a probability of wind of 37%. Related to the average temperatures detected, in July and August, when the average temperatures are the highest during the year (20°), the probability of wind is 32.5% with a direction range WSW-W (considering Beaufort  $\geq 4$ ). While, during the winter (December-February), when the average temperature is 5.7°, the probability of wind is 46.7% with a direction range SSW-SW. As a consequence, because of its orientation, the NNW oriented facades of the block receive the fresh summer breezes that flow parallel to them, while during winter, the presence of other buildings in the back of the block can limit the effect of the winter breezes, but only slightly as they are mainly two floors constructions.

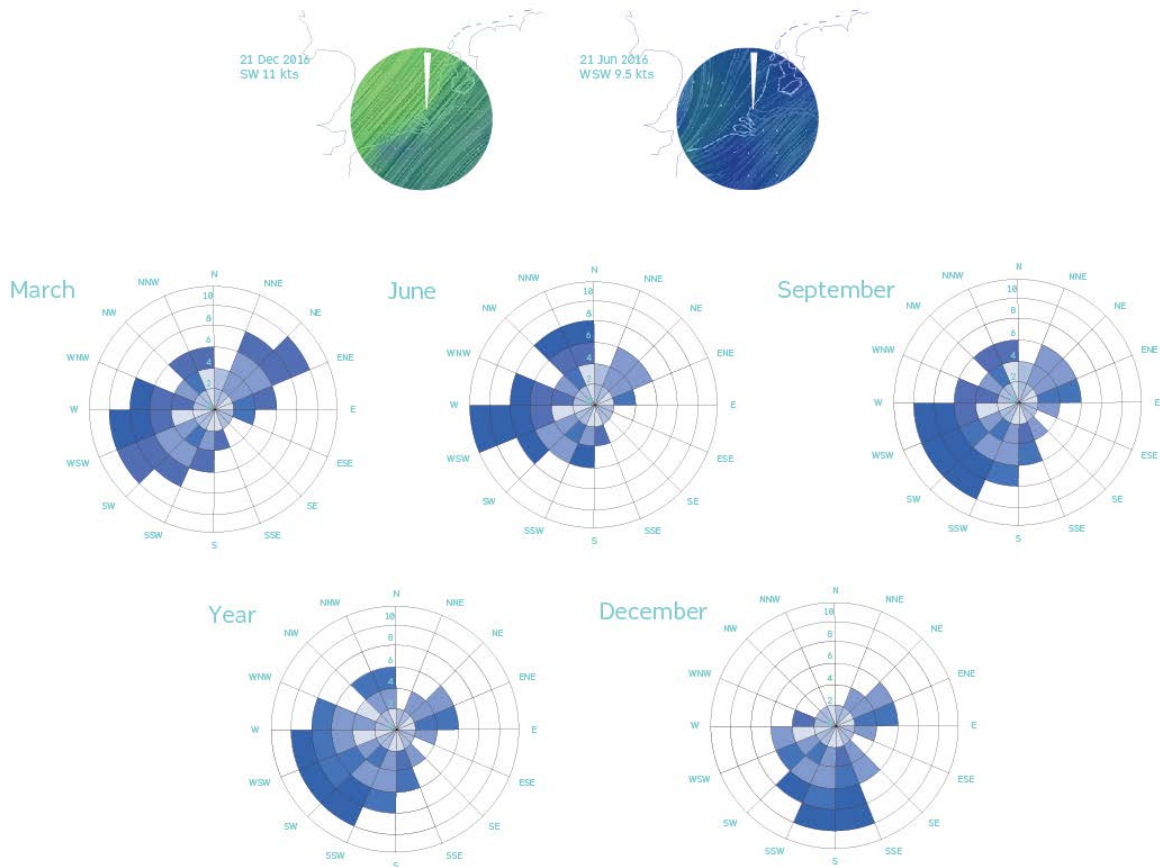

Figure 6.6 Wind directions (source: author)

### 6.1.5 Sun, wind and rain combination

By crossing the data available for the meteorological study, the best and worst conditions concerning the buildings can be evaluated, depending on different combinations between the atmospheric agents. The worst scenario happens in winter, when the low temperatures are accompanied by the scarce illumination of the buildings within the day and the high probability of wind coming from SW. In this case, the wind is not easily stopped before hitting the buildings because the port area does not represent an obstacle for it. Moreover, the orientation of the buildings (ENE-WSW) leads the wind to flow freely along the principal and back facades. Another scenario happens in October, when the probability and quantity of rain is high and the north facades are mainly shaded, in this case those sides remain wet for a long time before drying. In fact, it can be seen that the lower parts of the masonry walls are darker, probably due to the capillary rise of humidity and water that is stagnant for a long time. Finally, another scenario can be elaborated concerning the summer period, when the temperatures are the highest and wind can freely hit the west and north facades coming mainly from WSW. This can help during the hottest hours to gain ventilation through the south west openings in the buildings.

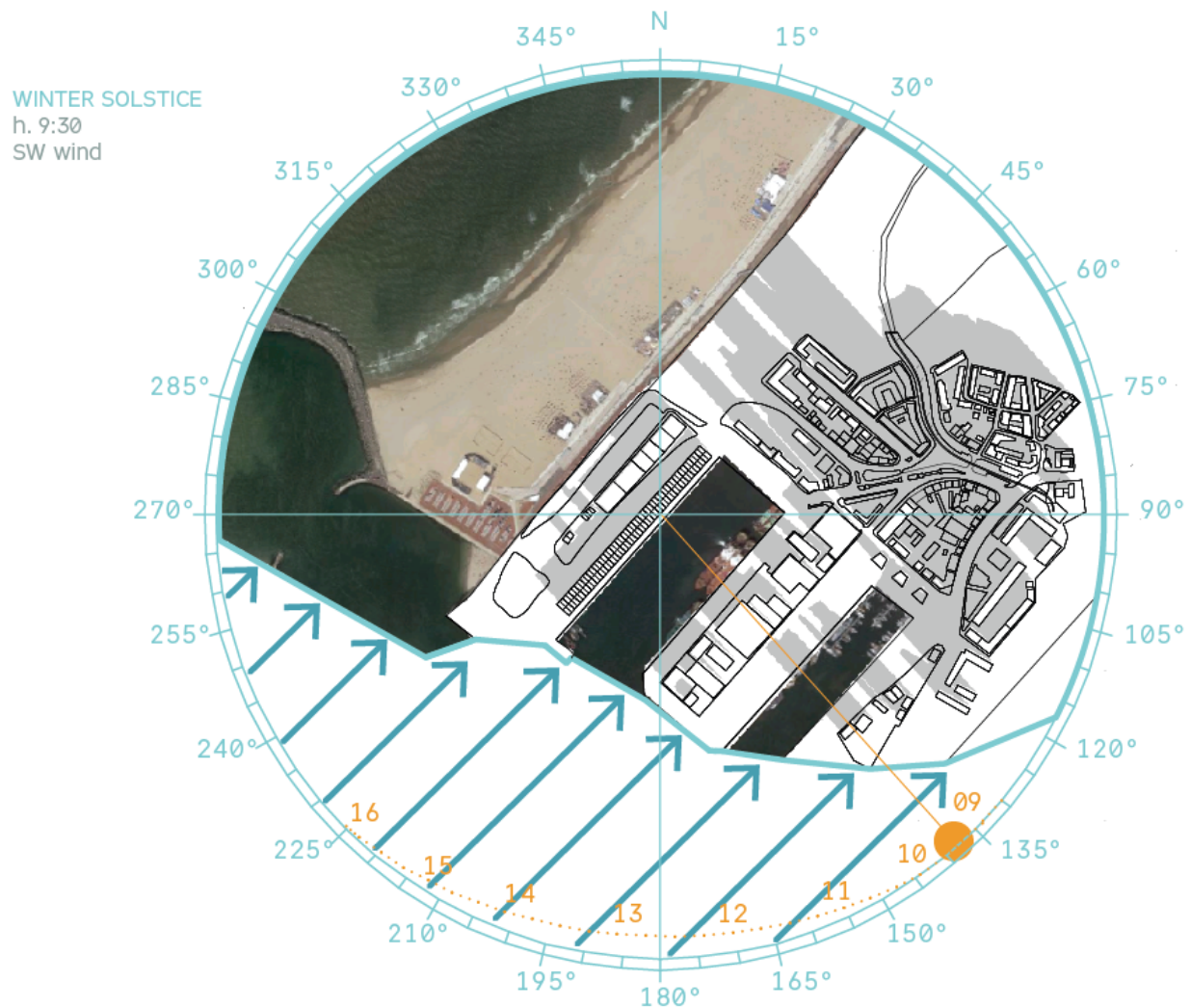
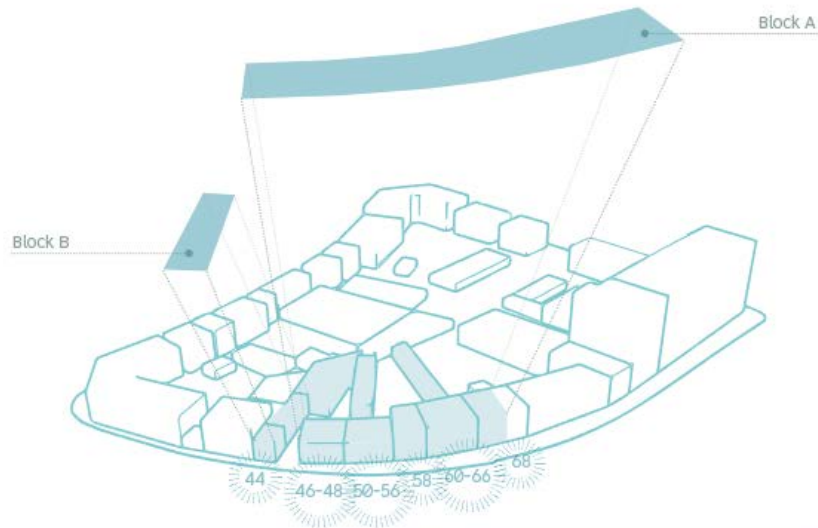

Figure 6.7 Combination of wind and shading in winter period (source: author; software: Autodesk Ecotect Analysis)

## 6.2 Construction criticalities

### 6.2.1 Brief history of the buildings

It was possible to have access to the real estate registry and drawings from the 1920 till the 2004 were available so that it was possible to understand the construction characteristics of the buildings. The buildings are identified with their civic numbers in order to simplify the description about their historical evolution. Moreover, in order to better distinguish the characteristics of the constructions, they will be divided in two blocks: block A is composed by civic numbers from 46 to 68, while block B is number 44. This division has been made also because the primary energy consumption is calculated separately for the two, as they are detached constructions.



*Figure 6.8 Partition in blocks A and B and related civic numbers (source: author)*

### 1920-1929

The cadastre of these years provides the facades drawings of the 46-48 building, proving that the façade have not changed since that period. It is shown that a masonry two layer structure was used with underpinning foundation and wooden beams floors. The same data is provided for buildings 50-56 and 58 as another frontal view is sketched, showing quietly the same façade appearing today. Another drawing shows the back front of buildings 50-56, 58 and 60, stating that the block was used as a warehouse, with wooden beams and planking for the floors.



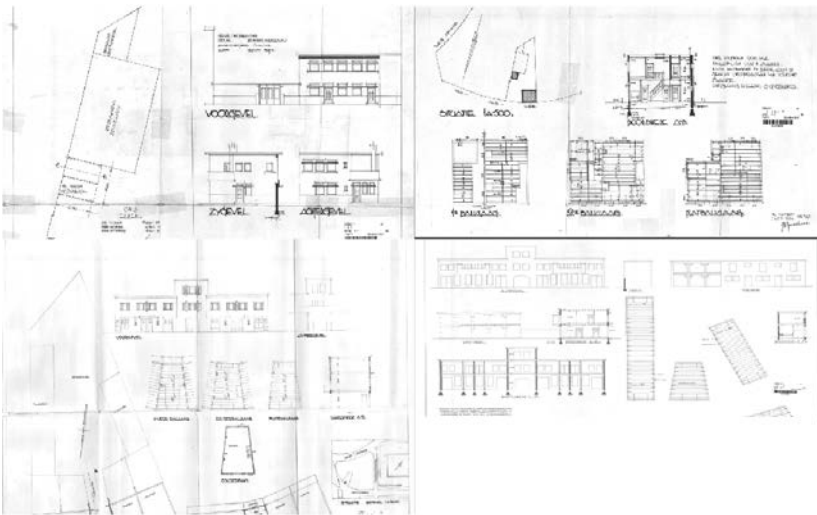

Figure 6.9 Available documents from the cadastre (1920-1929) (source: Urban Climate Architects)

### 1931-1938

This registry gives more detailed information about the floor layers of the warehouse hosted in buildings 50-56, 58 and 60. A section shows that, more specifically, the first order of beams was composed by INP steel profiles, while the second by wooden joists, covered by a wooden planking. In addition, the ground floor pillars were INP steel profiles, while in the second floor there were wooden pillars reinforced by diagonal joists in order to support the flat roof.

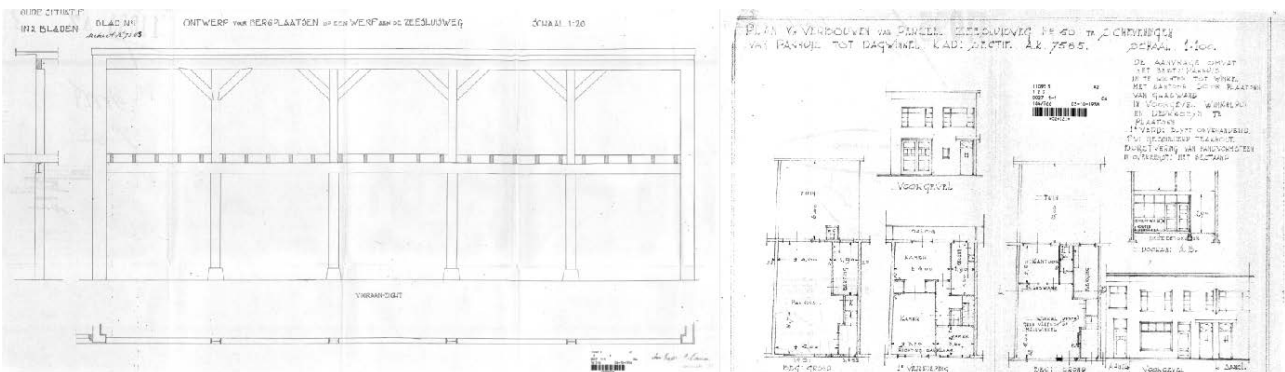

Figure 6.10 Available documents from the cadastre (1931-1938) (source: Urban Climate Architects)

### 1946-1947

This section gives information about the buildings situated in the inner part of the block, behind those facing Zeesluisweg .

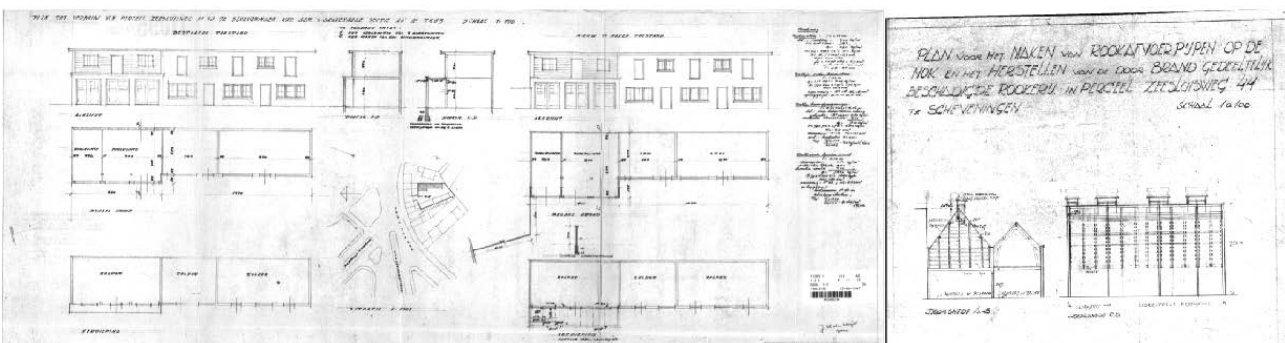

Figure 6.11 Available documents from the cadastre (1946-1947) (source: Urban Climate Architects)

1960-1969

These documents describe the renovation of building 60-66, concerning the creation of showcase at the ground floor and the application of stone wall tiles. Moreover, some drawings show that cork insulation panels had been positioned along the walls in order to insulate an engine room in the warehouse. In addition, some details are available for what concerns the reinforcing of the wooden beams in the floor structures of buildings 60-66.

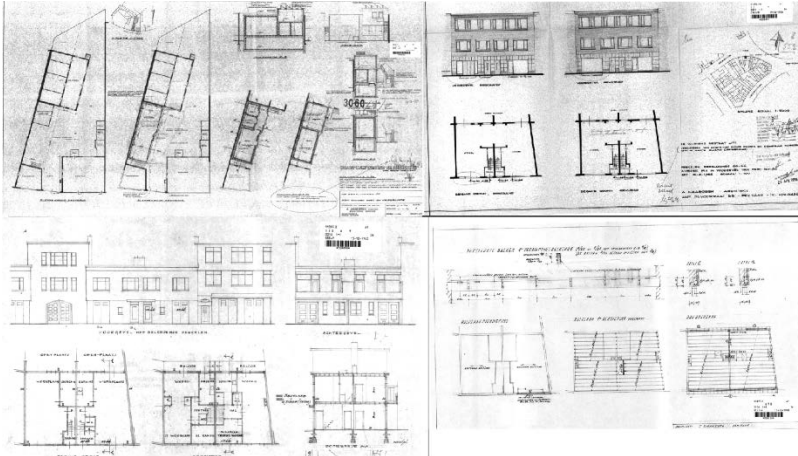

Figure 6.12 Available documents from the cadastre (1960-1969) (source: Urban Climate Architects)

In general, the floor thickness is about 30 cm, composed by structural wooden beams supporting a planking and connected to wooden boards for the ceiling. At the ground floor there is a suspended floor made of wooden beams and planking, while the walls' structure is made of a double layer of bricks with a total thickness of 22 cm.

### 6.2.2 Insulation and windows

Data regarding the presence of insulation in the floors and walls of the buildings is absent. Due to the fact that all the blocks were constructed in 1926, there was no aware of insulation measures to be applied.

About the openings, thanks to a field inspection, three different types of windows have been identified in the north facade: single glass wooden windows, double glass wooden windows and double glass PVC windows. As the lateral and back fronts were not accessible, it has been stated to consider for them single glass wooden windows, for safety during the energy demand calculation. More specifically, block A is provided by 70% single glass wooden windows with an area of 139 sqm, 28% double glass wooden windows with an area of 105 sqm and 2% PVC windows with an area of 12.76 sqm. The thermal transmittance of single glass wooden windows is  $5 \text{ W/m}^2\text{K}$ , the one for the double glass wooden windows is  $2.4 \text{ W/m}^2\text{K}$  as well as for the double glass PVC windows. Considering the four different orientations, the ratio between windows and wall area is: for the south 23%, for the east 14%, for the north 73%, while for the west is 0 because the block is adjacent to another building.

For what concerns block B, the windows in the north facade are all single glass wooden windows, while for the west orientation, they have been supposed again single glass wooden windows for safety during the energy consumption calculation. The windows area is 29.27% and the ratios between windows area and wall area, depending on the orientation are: 13% facing west and 50% facing north.

It is important to notice that the most opened façade is the north one and not the south and this could reflect in the low solar gains provided for the energy demand of the buildings.

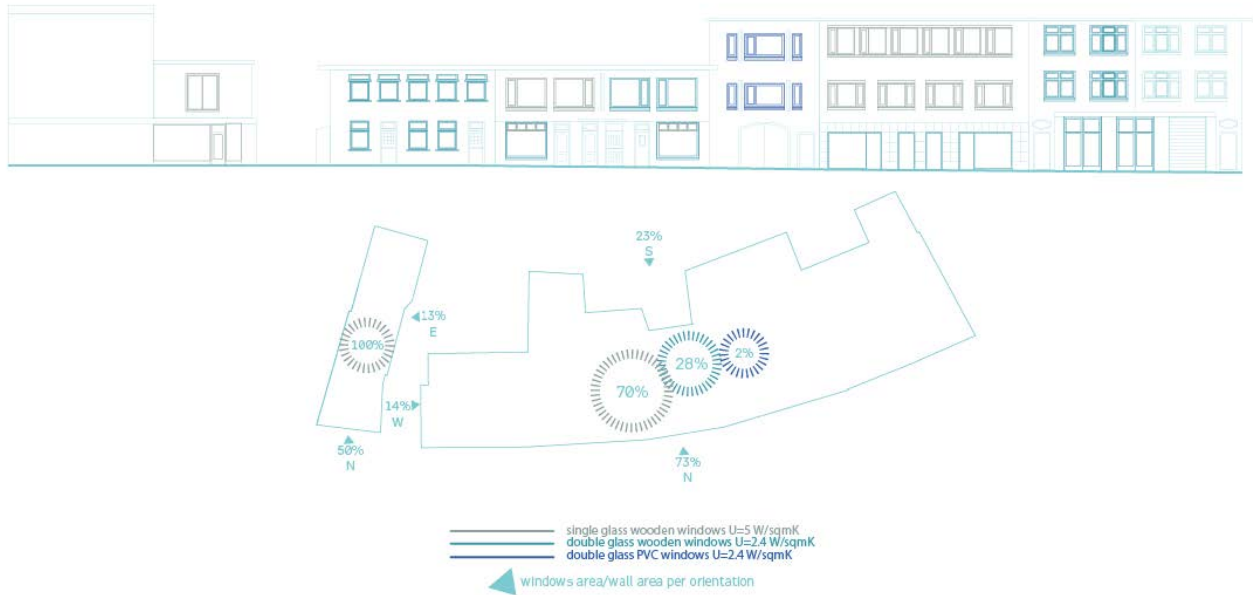

Figure 6.13 Windows distinction, percentages of windows type per block and ratios between windows area and wall area per orientation (source: author)

### 6.2.3 Distribution of functions

Block A hosts at the ground floor five dwellings, including a bar and a kindergarten, while at the first floor seven dwellings are located and at the second floor three of these dwellings develop their first floors. The total gross area of the block is 1616 sqm and the total heated area is 1127 sqm. Moreover, the total gross volume is 4847 cum with fourteen dwellings which average dimensions range from 50 sqm to 130 sqm. The total area for each floor is: 540 sqm for ground floor, 368 sqm for first floor and 219 sqm for second floor.

Block B hosts two dwellings per floor. The total gross area of the block is 244 sqm and the total heated area is 173 sqm. Moreover, the total gross volume is 733 cum and the average apartment surface is 40 sqm. The area for each floor is 86.6 sqm.

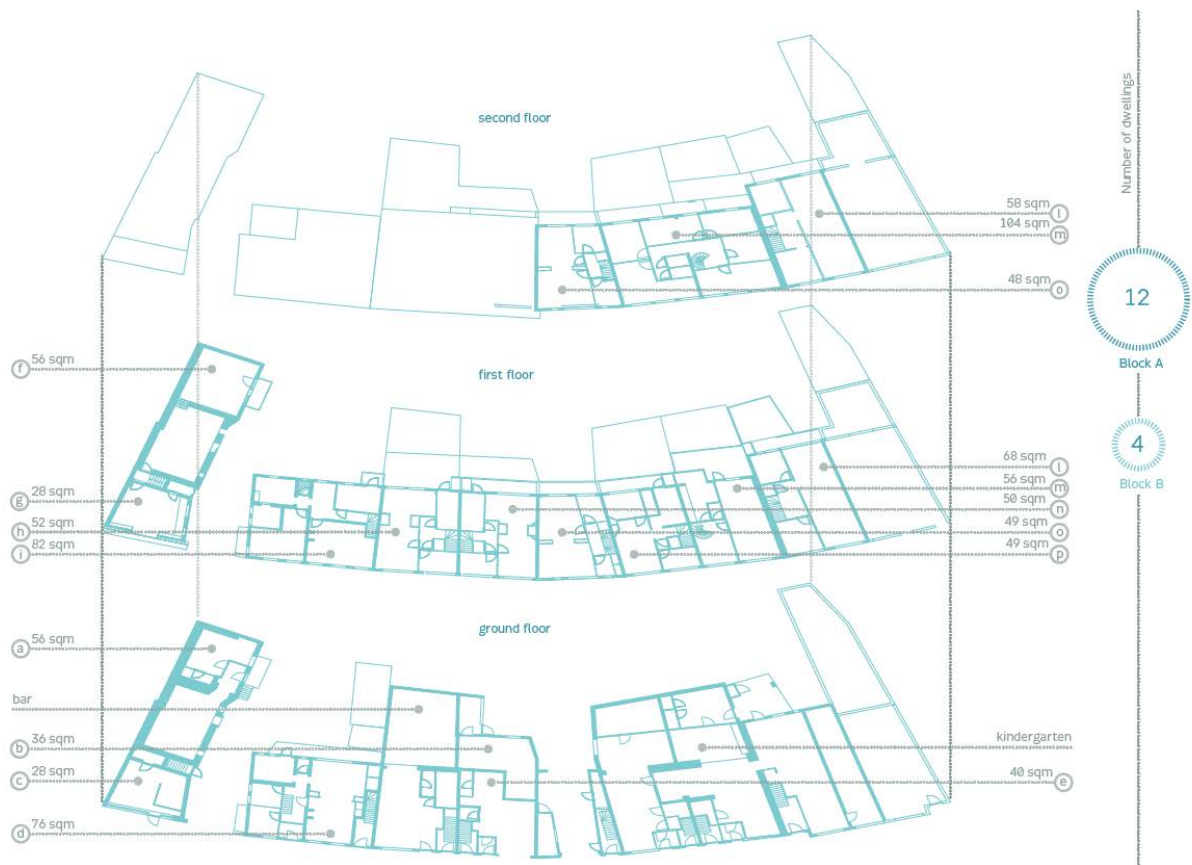

Figure 6.14 Partition of dwellings for each floor (source: author)

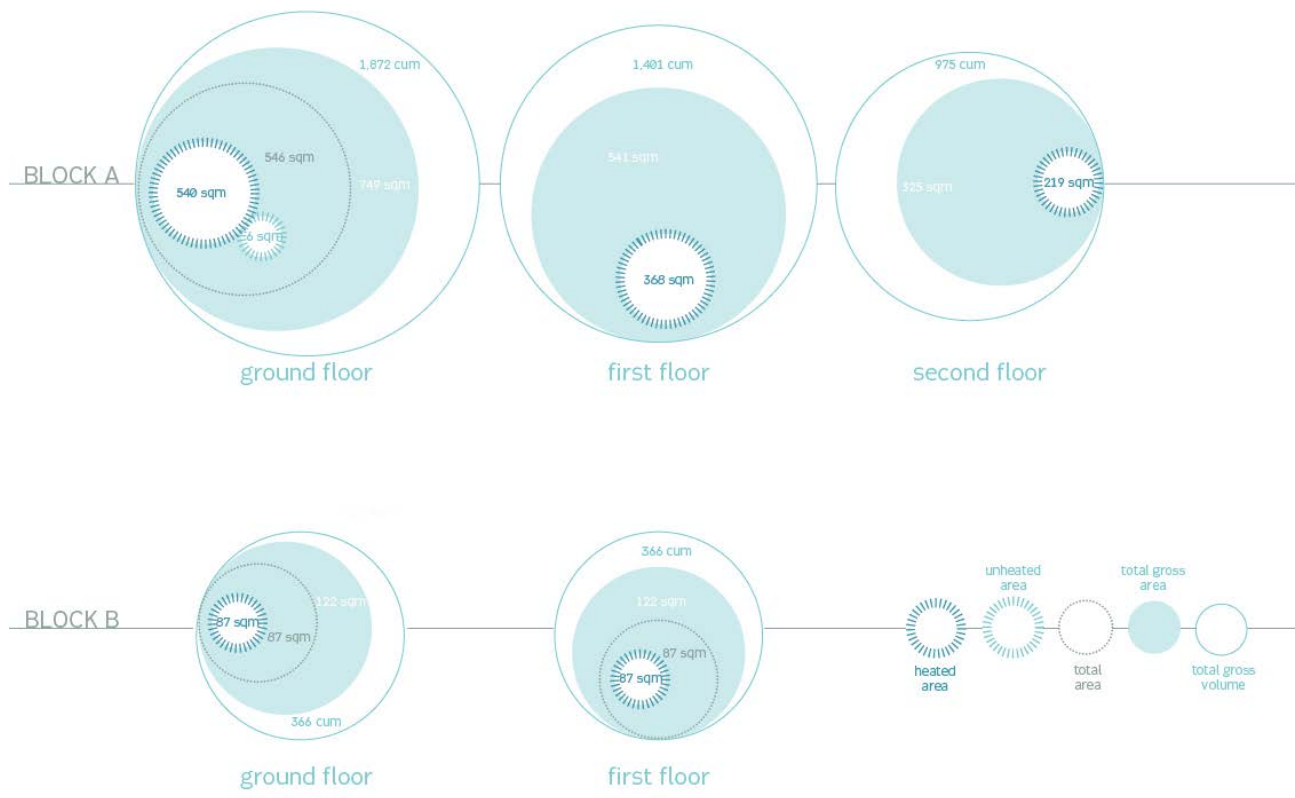

Figure 6.15 Blocks' dimensions (source: author)

## 6.2.4 Ventilation

Concerning the inner ventilation of the dwellings, it can be stated that six of them have an easy inner ventilation thanks to openings facing both north and south, while the other ten have a difficult inner ventilation due to either the absence of openings on both sides or the position of openings causing difficulties in air change.

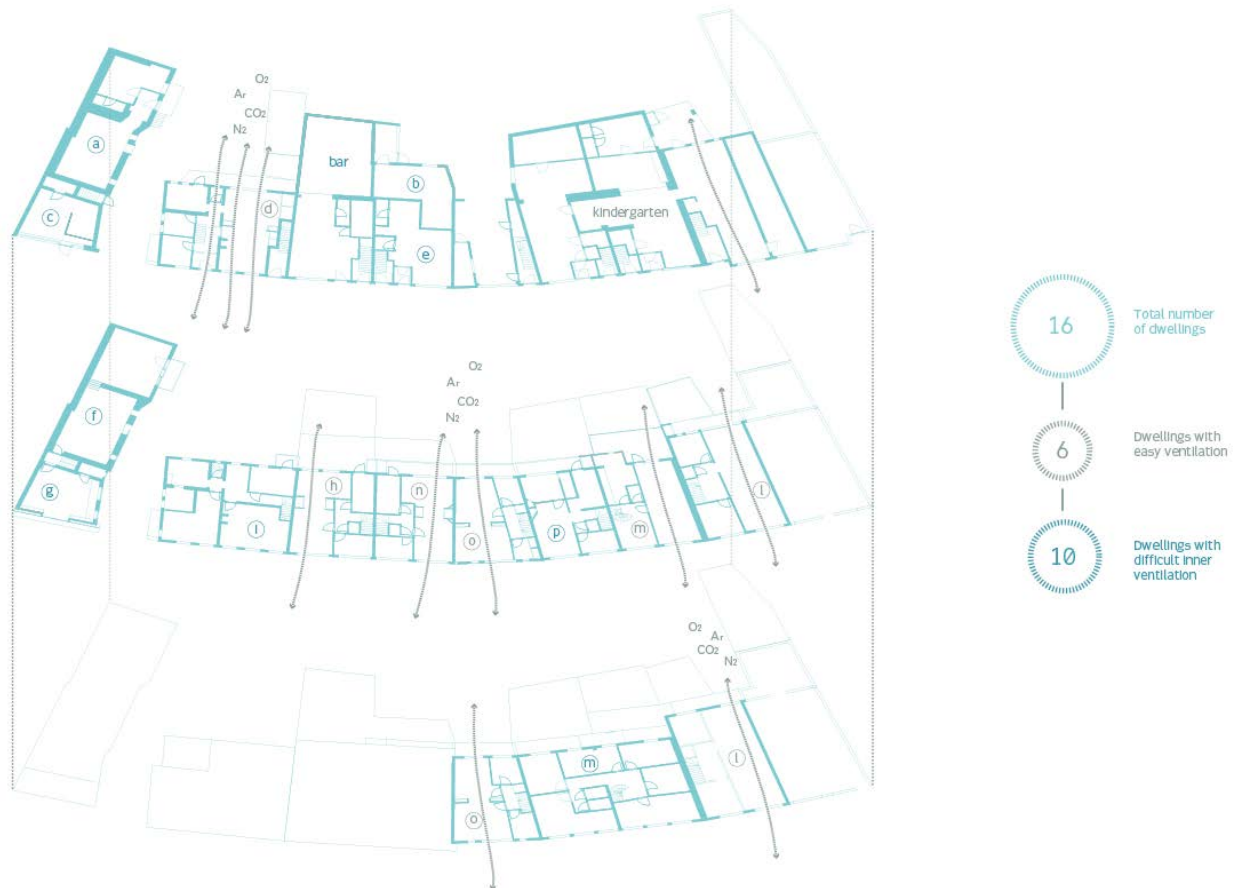

Figure 6.16 Inner ventilation in the dwellings (source: author)

## 6.2.5 Buildings' deterioration

All buildings are made of a double layer masonry structure and, because they were constructed in different periods, the brick colour and laying vary for each one. One of the most visible types of deterioration is the darkening of the lower parts of the façades, probably due to the stagnation of rain water. This effect is visible on the north façade that is not reached by direct sun rays and wind, so rain water easily leaves the surfaces wet for a long time, causing them to deteriorate and darken. Moreover, the closeness to the sea stimulates the creation of efflorescence due to the marine aerosol present in the air, as white spots can be seen on the north side. Concerning structural problems, it is well visible that the roof protrusion, made of painted wooden boards, is deteriorating, as some boards have fallen and some others are rot. Another structural problem occurs in building 68, where mixed stone layers frame the top of the openings. In one of them a crack is visible, while in another the steel connections between masonry and stone are visible and rusted, meaning that the carbonation process has caused them to deteriorate and expand. Finally, an aesthetic problem involves the entire north façade, due to the connections between each building and the several modifications occurred.

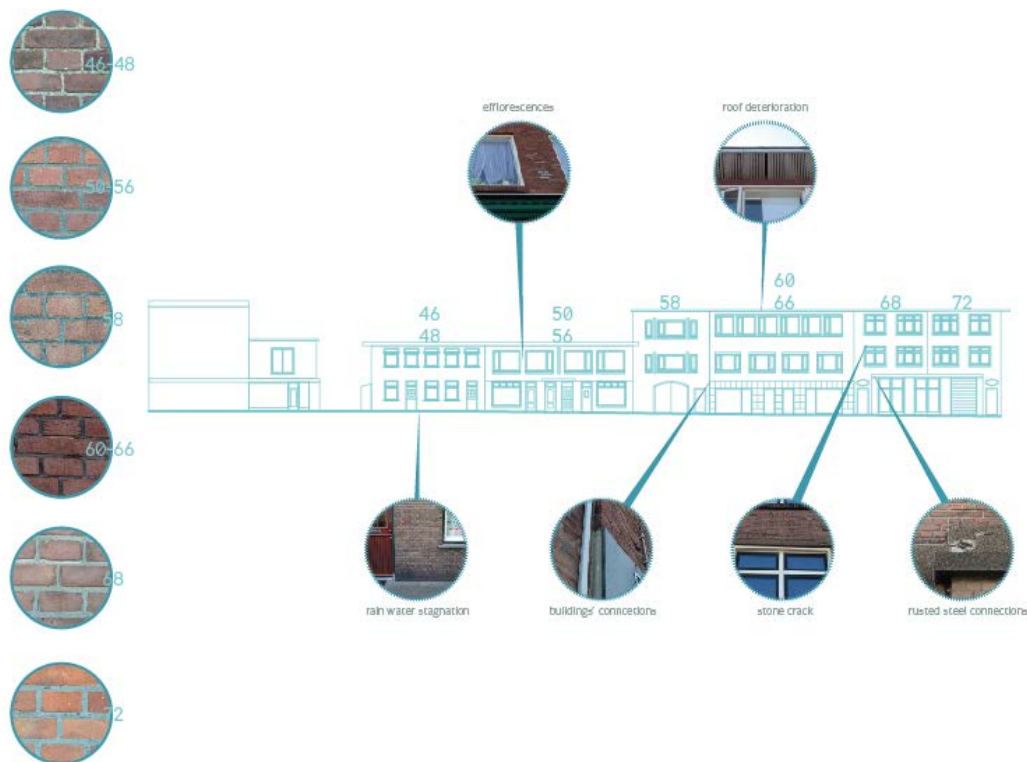

Figure 6.17 Brick types and buildings' deterioration (source: author)

### 6.3 SWOT Analysis

After having analysed all the environmental, climatic and structural aspects of the buildings, a summary of them can be elaborated by filling in the SWOT analysis. For what concerns the strengths of the site, the main aspects are: the presence of cycling lanes, the presence of public transport (both bus and tram), a good AQI (air quality index), the closeness to the sea and the sea view towards north-west. Concerning the weaknesses of the case study, the main topics are: the traffic during summer period, the noise coming from Zeesluisweg, the lack of permeable soil, the permanent shade on north façade (which is the principal façade), the combination of low temperature, rain, wind and shade on the north façade during winter period, the absence of insulation in the buildings' constructions, the predominance of single glass windows, the predominance of windows in the north façade than in the south one, the presence of difficult inner ventilation in 10 dwellings, the buildings' deterioration. As for the opportunities that the site provides, the following are stated: the possibility to add on a new construction on the existing one and behind it, the possibility to create an access between block A and B and the possibility to gain permeable soil if the demolition will not be followed by new construction. Finally, the threats represented by future interventions are analysed, as the impossibility to gain green areas due to new construction after demolition, the overcrowding of the area and the loss of facing brick in the existing facades by adding a thermal coat on them.

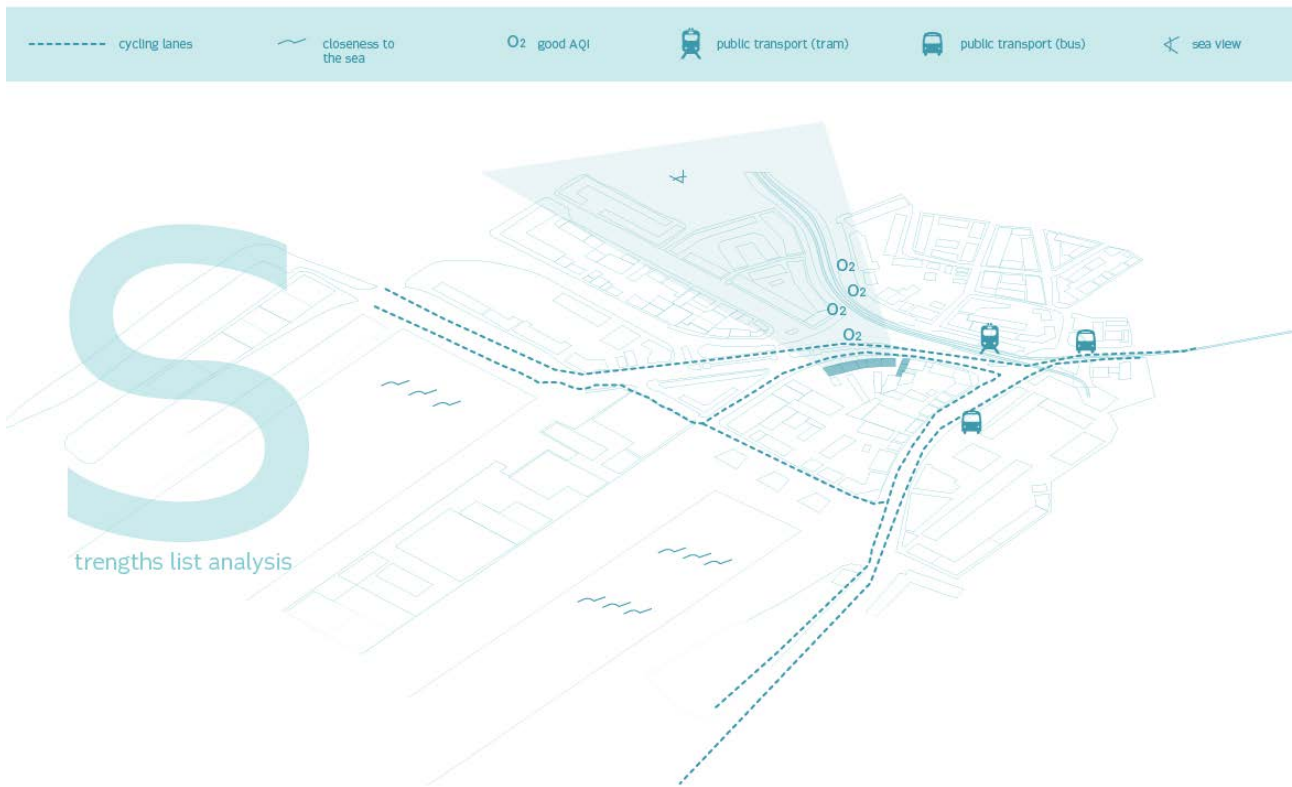

Figure 6.18 SWOT Analysis: strengths



Figure 6.19 SWOT Analysis: weaknesses (source: author)

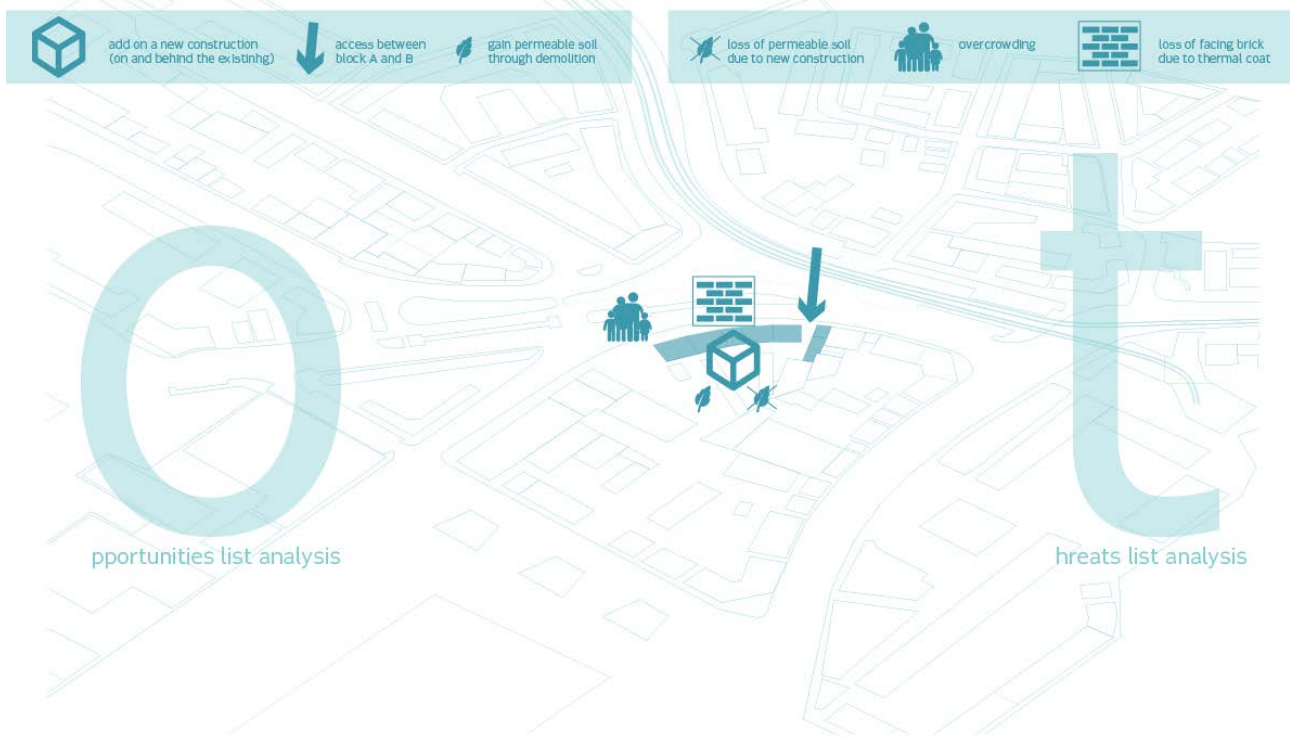

Figure 6.20 SWOT Analysis: opportunities and threats (source: author)

## 6.4 Energy Demand as built

In order to calculate the energy demand for the heating system of blocks A and B, the thermal transmittances of every architectural component have been evaluated. The roofs are composed by different layers: cement plaster in the inner side (thickness= 0.02 m, thermal resistance= 0.022 sqmK/W), wooden boards (thickness= 0.04 m, thermal resistance= 0.182 sqmK/W), wooden planking connected above the wooden beams (thickness= 0.04 m, thermal resistance= 0.182 sqmK/W) and a waterproof coating (thickness= 0.01, thermal resistance= 0.007 sqmK/W). The total thickness of the roof is 30 cm, considering the height of the beams, and the total thermal transmittance is 1.2 W/sqmK.

The ground floors are made of: a double order of wooden beams and a planking (thickness= 0.04, thermal resistance= 0.182 sqmK/W) for a total thickness of 30 cm and a total thermal transmittance of 3.11 W/sqmK.

The walls are composed by: a double brick layer (thickness= 0,21 m, thermal resistance= 0.3 sqmK/W) and cement plaster, for a total thickness of 22 cm and total thermal transmittance of 2.08 W/sqmK. The dimensions of the bricks are estimated to be 10x20x5 cm.

Finally, the single glass wooden windows have a thermal transmittance of 5 W/sqmK, while the double glass wooden and PVC windows have a thermal transmittance of 2.4 W/sqmK.



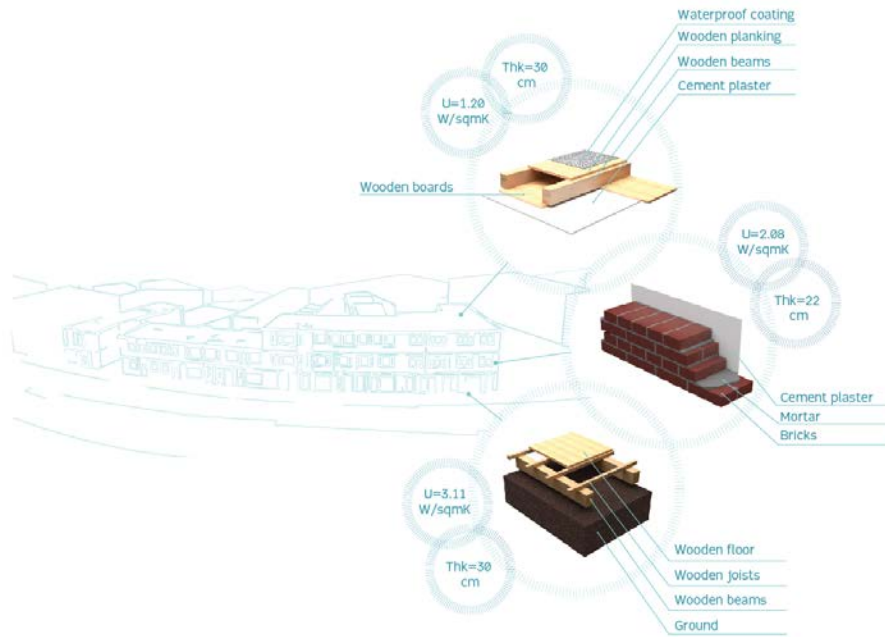

Figure 6.21 Architectural components' details: layers, thicknesses and thermal transmittances (U) (source: author)

ROOF	thickness (m)	conductivity (W/mK)	thermal resistance (sqmK/W)
External surface resistance	-	-	0.04
Waterproof coating	0.01	0.26	0.038
Wooden planking	0.04	0.22	0.182
Roof space	-	-	0.3
Wooden beams	0.19	-	-
Wooden boards	0.04	0.22	0.182
Cement plaster	0.02	0.9	0.022
Internal surface resistance	-	-	0.1
Total	0.3	-	0.833

Total thermal transmittance: 1.2 W/sqmK (U)

GROUND FLOOR	thickness (m)	conductivity (W/mK)	thermal resistance (sqmK/W)
Internal surface resistance	-	-	0.1
Wooden floor	0.04	0.22	0.182
Wooden joists	0.06	-	-
Wooden beams	0.2	-	-
External surface resistance	-	-	0.04
Total	0.3	-	0.322

Total thermal transmittance: 3.11 W/sqmK (U)

WALLS	thickness (m)	conductivity (W/mK)	thermal resistance (sqmK/W)
Internal surface resistance	-	-	0.13
Cement plaster	0.01	0.9	0.011
Brick wall	0.21	0.7	0.3
External surface resistance	-	-	0.04
Total	0.22	-	0.481

Total thermal transmittance: 2.08 W/sqmK (U)

Table 6.1 Thermal transmittances: roof, ground floor and walls (source: author)

In order to obtain the Energy demand for each building, energy dispersions and gains must be evaluated. For what concerns the energy losses, they happen by ventilation and through the building's shell:

$$Q_D = Q_T + Q_V [kWh]$$

$Q_T$ : dispersions through transmission

$Q_V$ : dispersions through ventilation

Where general formula for dispersions is:

$$Q_{T,V} = U \times A \times (\theta_i - \theta_e) \times t$$

U: thermal transmittance

A: area

$(\theta_i - \theta_e)$ : difference between internal and external temperature

t: time

While the energy gains are calculated as follows:

$$Q_G = \eta_G \times (Q_I + Q_S) [kWh]$$

$\eta_G$ : coefficient of use

$Q_I$ : internal gains

$Q_S$ : solar gains

As a consequence, the Net Energy Demand is calculated as:

$$Q = Q_D - Q_G [kWh]$$

And the Primary Energy Demand:

$$Q_P = \frac{Q}{\eta} [kWh]$$

$\eta$ : global efficiency of system plant

Finally, the Primary Energy Index, is calculated as follows:

$$PEI = \frac{Q_P}{A} [kWh / m^2 year]$$

By using an excel sheet, in particular a model prepared for ABRACADABRA Project by Professor Nicola Semprini, it has been stated that the PEI for block A is around 348 kWh/sqm year, while for block B is 469 kWh/sqm year. Both indexes widely come under the energy label G, following the latest Dutch energy policies (ISS082).

Both values are considerably high and this could be estimated as the "prebound effect", that is the overestimation of the consumption before renovation. It is mainly caused by the uncertainty in technical and climatic data inputs and the simplicity of the calculation models used (excel sheets). The architectural components of the case study were presumed using the few information available from the historical archives. Moreover, local heating systems as gas boilers have been supposed for both blocks (global efficiency: 0.75), as no information were available. In addition, another assumption concerned the lateral and back facades

windows of both blocks as they were not accessible and they have been assumed as single glass wooden windows for safety. Finally, it must be underlined that the energy consumption includes only the assumed heating system.

By considering a cost of 0.65 euros per cubic meter of natural gas, an evaluation of the annual energy cost can be estimated. For block A it has been stated that the monthly average cost of energy for each dwelling is about 177 euros, while for block B it is about 110 euros. Both values are considerably high, in relation to the actual average costs for dwellings of 50-150 sqm, but this overestimation is again connected to the above mentioned "prebound effect".

For what concerns the solar gains, using the software Ecotect, it has been verified that the north façade receives the lowest irradiation, in addition the south façade does not receive as much irradiation as could be expected because of the presence of other buildings, some of them higher, that stop the sun rays. The flat roofs receive the most of the irradiation during the day. The analysis has been conducted evaluating the winter period, in which solar gains are required in order to reduce the use of heating systems.

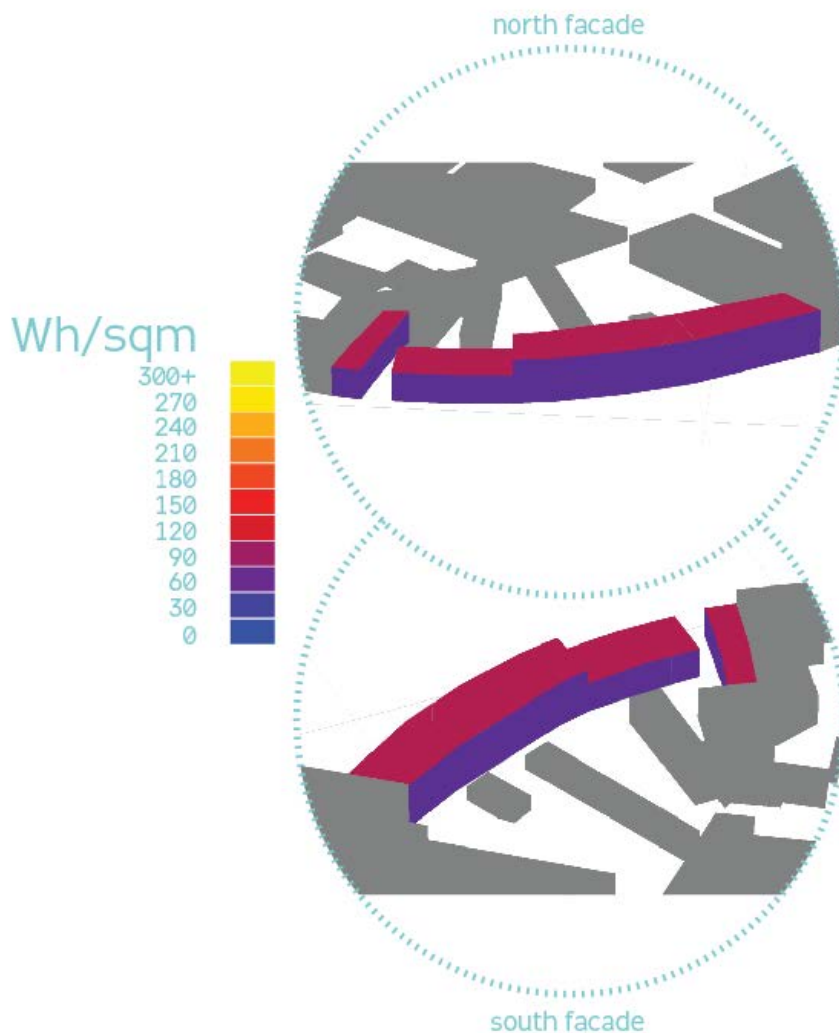

Figure 6.22 Daily average irradiation on north and south facades during winter period (source: author; software: Autodesk Ecotect Analysis)

BLOCK A		net internal surface: 1,127 sqm
Net Energy Demand	293,493	kWh
Primary Energy Demand	392,753	kWh
Primary Energy Index	348	kWh/sqm year
Fuel Consumption	39,275	cum
Total annual cost	25,529	euros
Monthly average cost per dwelling	177	euros
Energy label	G	

Table 6.2 PEI and annual energy cost for block A (source: author)

BLOCK B		net internal surface: 173 sqm
Net Energy Demand	60,639	kWh
Primary Energy Demand	81,147	kWh
Primary Energy Index	469	kWh/sqm year
Fuel Consumption	8,115	cum
Total annual cost	5,275	euros
Monthly average cost per dwelling	110	euros
Energy label	G	

Table 6.3 PEI and annual energy cost for block B (source: author)

By considering the sum of block A and B, the primary energy index is 407 kWh/sqm year. It has also been calculated using the Dutch national calculation model, obtaining a PEI value of 478 kWh/sqm year. In this case the calculation has been developed by considering the blocks as the sum of the dwellings they host. One of the main differences between the two models is that the heating period considered by the national model is longer than that considered in the excel sheet used for the evaluation, that is fixed on considering a period of six months and a half.

## 7 Design phase

The design phase starts with the energy retrofitting of the existing blocks, A and B, in order to decrease the Primary Energy Index and reach the A energy label. These interventions can

be operated thanks an economic investment. The cost-benefit analysis states the feasibility of these interventions, elaborating several incremental scenarios with different payback times.

## 7.1 Energy renovation of the existing

The energy renovation of these types of buildings is mainly characterised by the addition of insulation to each architectural component in order to limit the heat dispersions towards the exterior.

Concerning the roof, 19 cm wood fiber panels are placed between the wooden beams and another 3 cm panel is placed between the wooden planking and two layers of waterproof coating, in addition a vapour barrier is put between the wooden boards and the wooden beams. With this insulation the roof's thermal transmittance falls from 1.2 W/sqmK to 0.16 W/sqmK and the total thickness increases from 30 cm to 34 cm.

As for the ground floor, 20 cm wood fiber panels are placed between the wooden beams and a thin layer of nonwoven is placed between the panels and the ground. As a consequence, the thermal transmittance of the ground floor falls from 3.11 W/sqmK to 0.18 W/sqmK and the total thickness remains the same.

For what concerns the walls, a thermal coat is applied and the total thickness increases from 22 cm to 47 cm. The new layers consist of a vapour barrier put in the outer side of the existing bricks, a 10 cm wood fiber panel and a single layer of soft paste bricks, separated from the insulation panel by a 3 cm air cavity. This type of thermal coat is produced by an Italian company called San Marco and the soft paste bricks are "hand" printed and not extruded and then cooked in methane oven.

Finally, all the windows are replaced with double glass PVC windows with a thermal transmittance of 1.2 W/sqmK, while the previous single glass wooden windows and double glass wooden and PVC windows had respectively thermal transmittances of 5 and 2.4 W/sqmK.

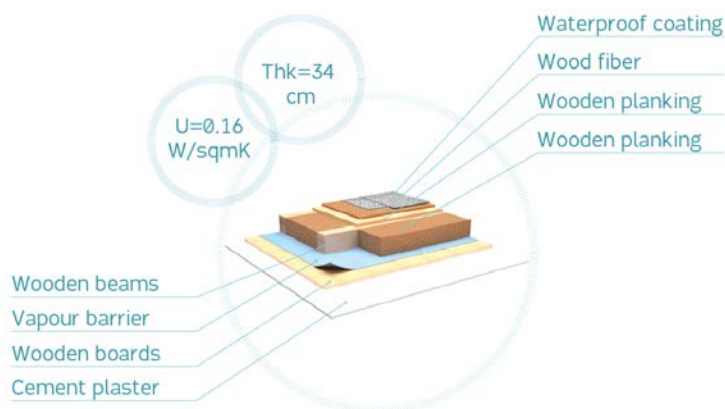

Figure 7.1 New roof's layers (source: author)

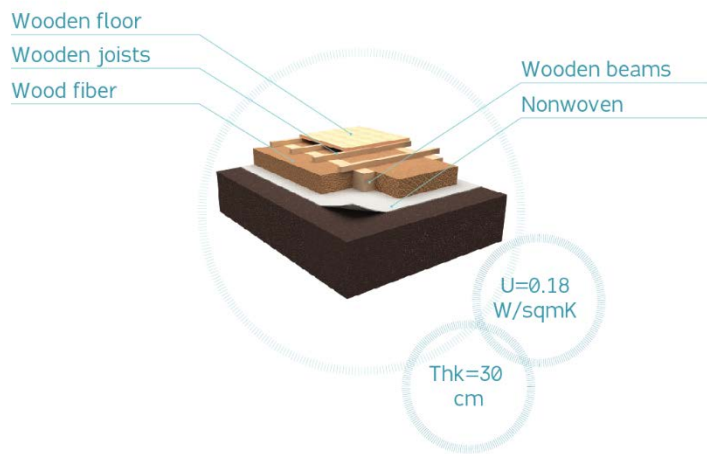

Figure 7.2 New ground floor's layers (source: author)

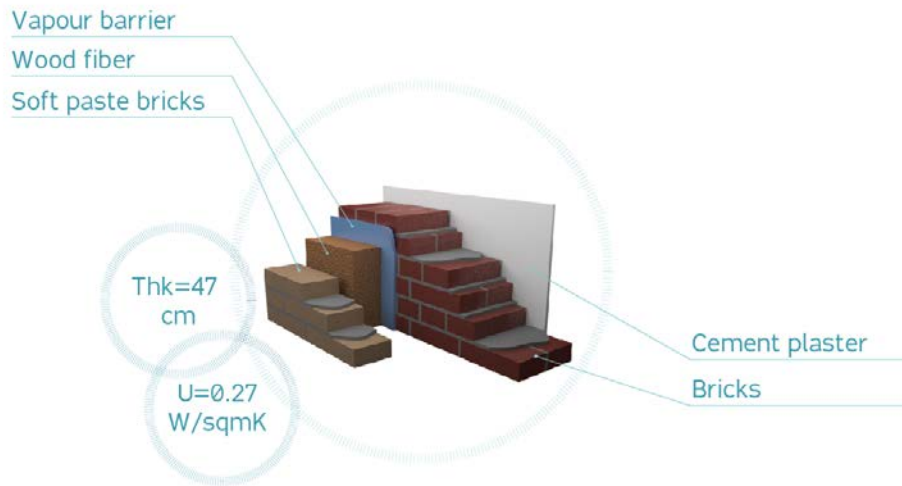

Figure 7.3 New walls' layers (source: author)

ROOF	thickness (m)	conductivity (W/mK)	thermal resistance (sqmK/W)
External surface resistance	-	-	0.04
Waterproof coating	0.01	0.26	0.038
Waterproof coating	0.01	0.26	0.038
Wood fiber	0.03	0.038	0.789
Wooden planking	0.04	0.22	0.182
Wood fiber	0.19	0.038	5
Vapour barrier	0.001	-	-
Wooden beams	0.19	-	0.1
Wooden boards	0.04	0.22	0.182
Cement plaster	0.02	0.9	0.022
Internal surface resistance	-	-	0.1
Total	0.34	-	6.33

Total thermal transmittance: 0.16 W/sqmK (U)



# GROUND FLOOR

	thickness (m)	conductivity (W/mK)	thermal resistance (sqmK/W)
Internal surface resistance	-	-	0.1
Wooden floor	0.04	0.22	0.182
Wooden joists	0.06	-	-
Wood fiber	0.2	0.038	5.263
Wooden beams	0.2	-	-
Nonwoven	0.002	-	-
External surface resistance	-	-	0.04
Total	0.3	-	5.585

Total thermal transmittance: 0.18 W/sqmK (U)

WALLS	thickness (m)	conductivity (W/mK)	thermal resistance (sqmK/W)
Internal surface resistance	-	-	0.13
Cement plaster	0.01	0.9	0.011
Brick wall	0.21	0.7	0.3
Vapour barrier	0.001	-	-
Wood fiber	0.1	0.038	2.632
Air	0.03	-	0.18
Soft paste brick	0.12	0.344	0.349
External surface resistance	-	-	0.04
Total	0.47	-	3.642

Total thermal transmittance: 0.27 W/sqmK (U)

Table 7.1 New thermal transmittances: roof, ground floor and walls (source: author)

## 7.2 Energy Demand as designed

After having applied these energy efficiency measures, the PEI for each building has been calculated and it has been stated that block A has a PEI of 39 kWh/sqm year with a supposed monthly energy cost per dwelling of around 24 euros. For what concerns block B, the PEI is 49 kWh/sqm year and the average monthly cost per dwelling is around 12 euros. Both blocks have reached the energy label A, although it must be reminded that the numeric values are widely estimated due to the initial uncertainty about the available data.

BLOCK A		net internal surface: 1,127 sqm	
Net Energy Demand	40,368	kWh	
Primary Energy Demand	44,361	kWh	
Primary Energy Index	39	kWh/sqm year	
Fuel Consumption	4,436	cum	
Total annual cost	2,883	euros	
Monthly average cost per dwelling	24	euros	
Energy label	A		

Table 7.2 PEI and annual energy cost for block A after energy renovation (source: author)

BLOCK B		net internal surface: 173 sqm	
Net Energy Demand	7,778	kWh	
Primary Energy Demand	8,548	kWh	
Primary Energy Index	49	kWh/sqm year	
Fuel Consumption	855	cum	
Total annual cost	556	euros	
Monthly average cost per dwelling	12	euros	
Energy label	A		

Table 7.3 PEI and annual energy cost for block B after energy renovation (source: author)

The PEI for both blocks has been calculated with a cumulative method by adding step by step each energy efficiency measure in order to evaluate its weight and importance in the decrease of the energy consumption of the dwellings. About block A, the most important measure that converts its energy label from G to C, is the walls' insulation that is added to the improvement in the heating systems' efficiency and the change of windows with more performing ones.

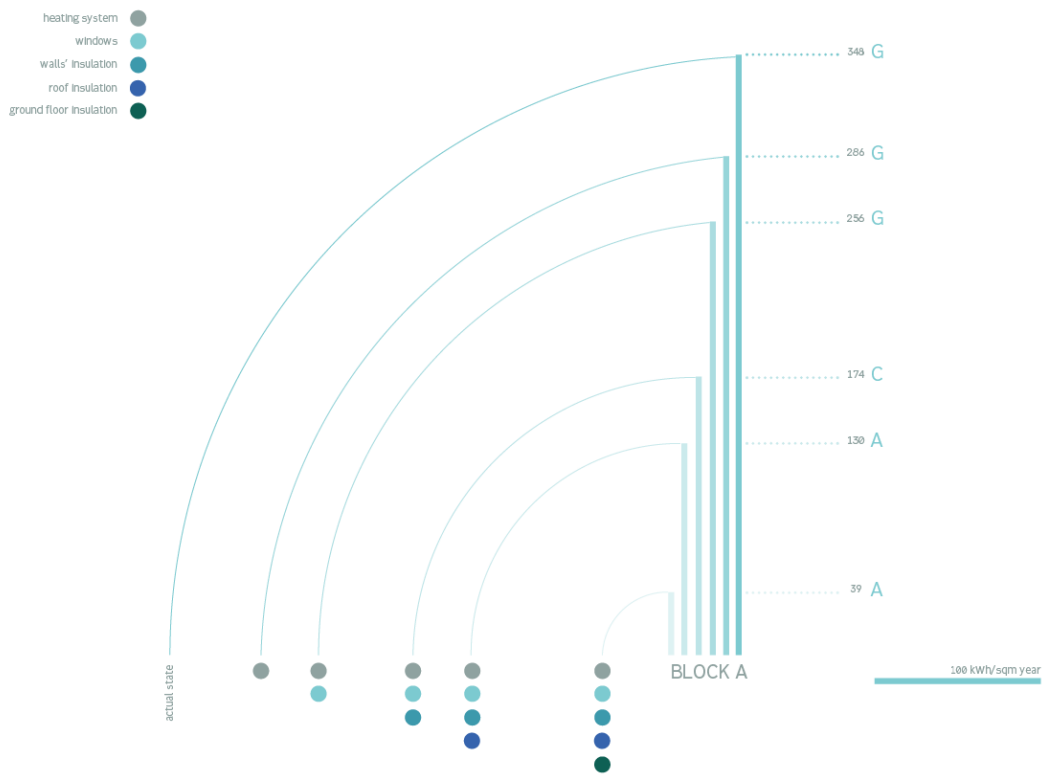

Graph 6.1 Cumulative scenarios for block's A PEI in kWh/sqm year (source: author)

Also for block B the most powerful energy efficiency measures combination consists of the change of heating systems, the change of windows and the adding of a thermal coat to the walls. This approach makes the energy label to change from G to E and states that, for both blocks, the adding of a thermal coat is the most powerful energy efficiency measure.

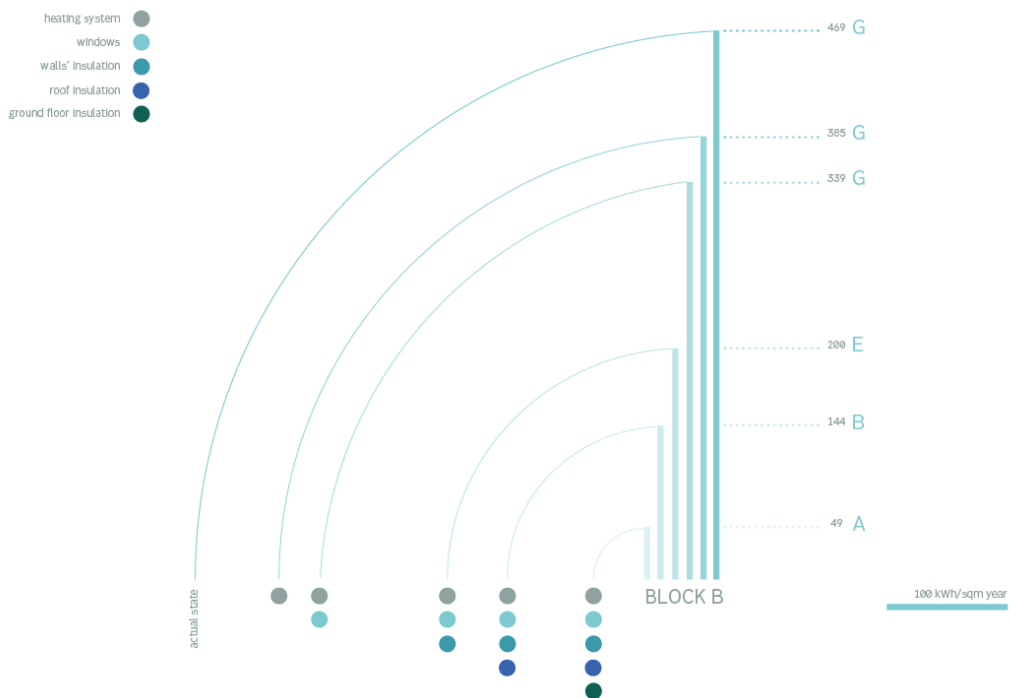

Graph 6.2 Cumulative scenarios for block's B PEI in kWh/sqm year (source: author)

Moreover, it has been conducted an analysis by obtaining different combinations of the energy efficiency measures in order to state their weight in the energy renovation process.

As for block A, it is clear that the change of windows is not so significant, while the combination of the improvement in heating system's efficiency with the adding of walls' insulation and the adding of roof's or ground floor's insulation, seems to be the more convenient. Moreover, the combination of all four measures decreases consistently the EPI.

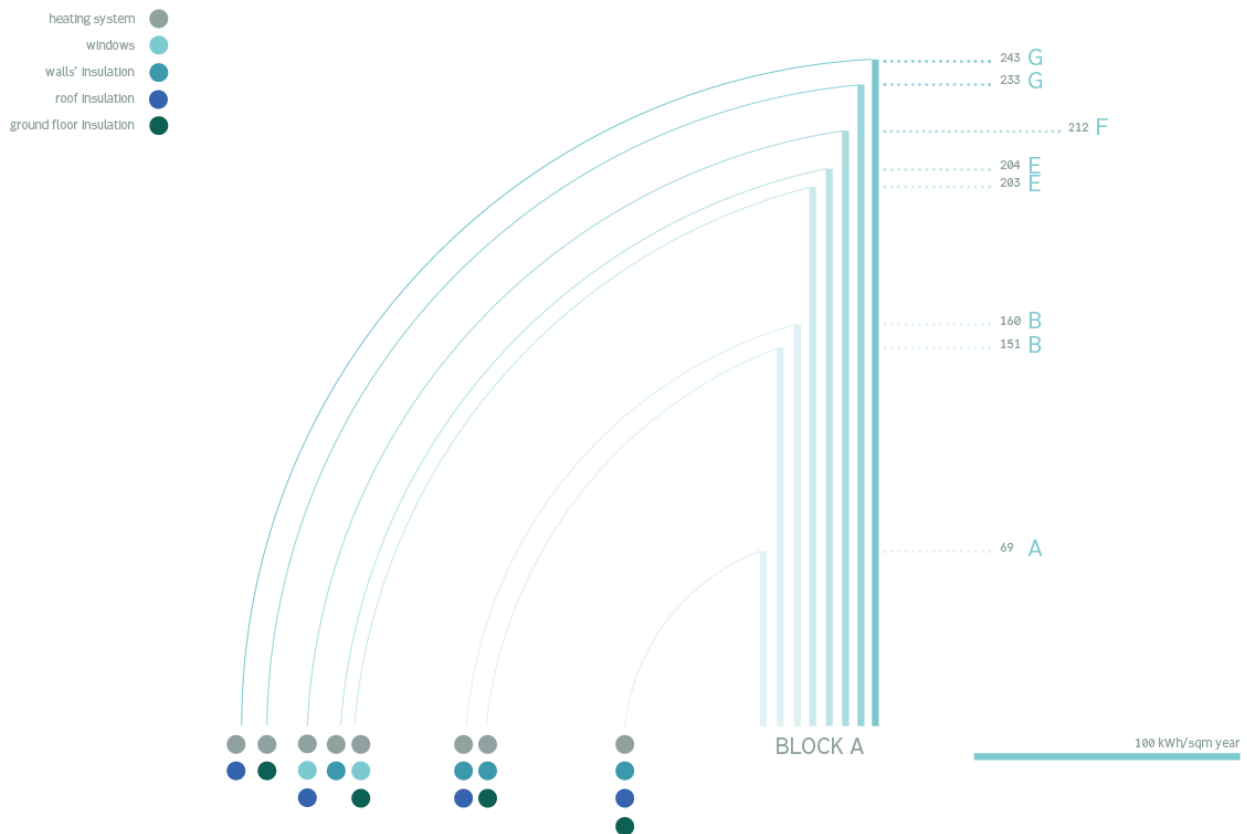

Graph 6.3 Different energy efficiency measures combinations for block A in kWh/sqm year (source: author)

About block B, the most powerful combination is the changing of heating systems, the adding of walls' insulation and the adding of insulation for both roofs and ground floors. Again, the change of windows does not seem to be relevant for the decrease of the EPI.

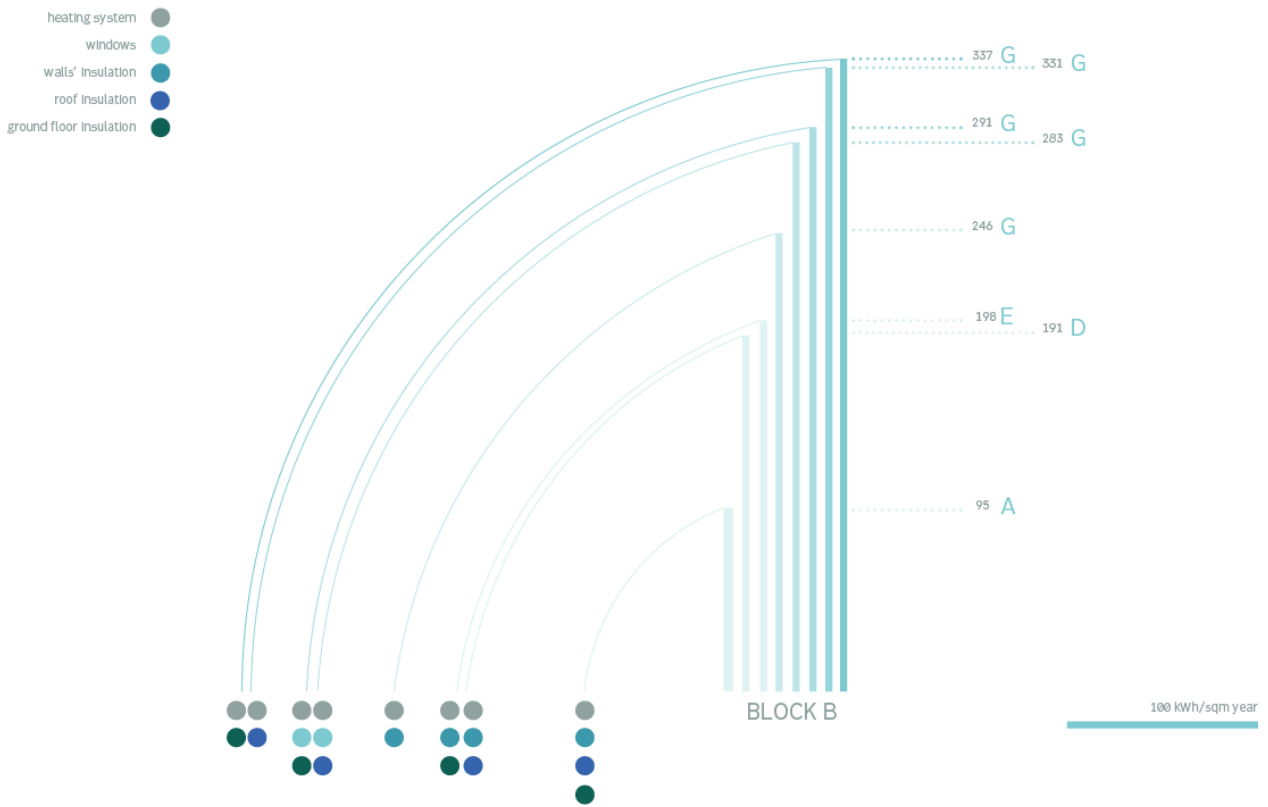

Graph 6.4 Different energy efficiency measures combinations for block B in kWh/sqm year (source: author)

As the final purpose is to reach the nZEB standard, photovoltaic panels of monocrystalline silicon will be used to cover the remaining energy need of the buildings. It has been calculated that for block A a photovoltaic surface of 98 sqm is needed in order to cover the 39 kWh/sqm year, with a total cost of 58,543 euros or 43 euros/sqm. For what concerns block B, a photovoltaic surface of 15 sqm is needed to cover the 49 kWh/sqm year with a total cost of 9,248 euros or 53 euros/sqm. The annual solar radiation data has been taken from the [www.solargis.com](http://www.solargis.com) site and it has a value of 1,100 kWh/sqm year.

BLOCK A		net internal surface: 1,127 sqm
PEI after retrofitting	39	kWh/sqm year
Electric Energy Demand	21,466	kWh
Peak power needed	20	kWp
Photovoltaic surface needed	98	sqm
Total cost	58,543	euros
Cost per square meter	43	euros/sqm

## BLOCK B

net internal surface: 173 sqm

PEI after retrofitting	49	kWh/sqm year
Electric Energy Demand	3,391	kWh
Peak power needed	3	kWp
Photovoltaic surface needed	15	sqm
Total cost	9,248	euros
Cost per square meter	53	euros/sqm

Table 7.4 Photovoltaic surface needed and total cost for blocks A and B (source: author)

A comparison between the PEI obtained with the wood fiber insulation addition and the one obtained with national energy efficiency measures can be done. In particular, the national standards consider to add polyurethane to the walls and to the ground floor and stone wool to the roof. As for the change of the windows, the same transmittance values are obtained as double glass PVC windows are used instead of the existing ones. The PEI obtained with the national standards is 44 kWh/sqm year for block A and 54 kWh/sqm year for block B.

	PROPOSAL	NATIONAL STANDARD INTERVENTIONS	
Roof's insulation	wood fiber	stone wool	
Walls and ground floor's insulation	wood fiber	polyurethane	
Roof's thermal transmittance	0.16	0.24	W/sqm K
Ground floor's thermal transmittance	0.18	0.25	W/sqm K
Walls' thermal transmittance	0.27	0.25	W/sqm K
Primary Energy Index Block A	39	44	kWh/sqm year
Primary Energy Index Block B	49	54	kWh/sqm year

Table 7.5 PEIs comparison: proposed interventions and national standard interventions

### 7.3 Local regulations on physical planning

Regarding the possible building interventions that could be made in the Case Study area, information has been obtained by contacting the Municipality of The Hague. It has been clarified that, in the case of a rooftop elevation on the existing buildings facing the road, a maximum height of 18 meters can be reached, while, regarding the buildings inside the block, the ones that will be demolished, a maximum height of 9 meters can be reached by the new constructions. More specifically, considering an average height for each floor of 3 meters, a maximum of four floors can be built on the existing buildings with civic numbers ranging from 44 to 56, and a maximum of three floors can be built on the existing buildings with civic numbers ranging from 58 to 68. Regarding the demolition area, a new construction of three floors can be built. The whole area is classified as mixed use and it is stated that no more than 80% of the whole land of the block (between Zeesluisweg Road, Westduinweg Road and Schokkerweg Road) can be built. In addition, an environmental permission must be required before starting the works.

Moreover, as design statement, the maximum ground floor area occupied by the new construction in the demolition area, will not be bigger than the actual ground floor occupied area, 747 sqm, in order to gain permeable soil. Regarding the rooftop additions on the existing blocks A and B, an elevation on both blocks could cover a maximum of 536 sqm (total roof surface), while a single rooftop addition on civic numbers 44 to 56 or 58 to 68 could cover respectively a maximum surface of 212 sqm and 324 sqm. Moreover, a rooftop addition on block B could cover a maximum surface of 122 sqm.

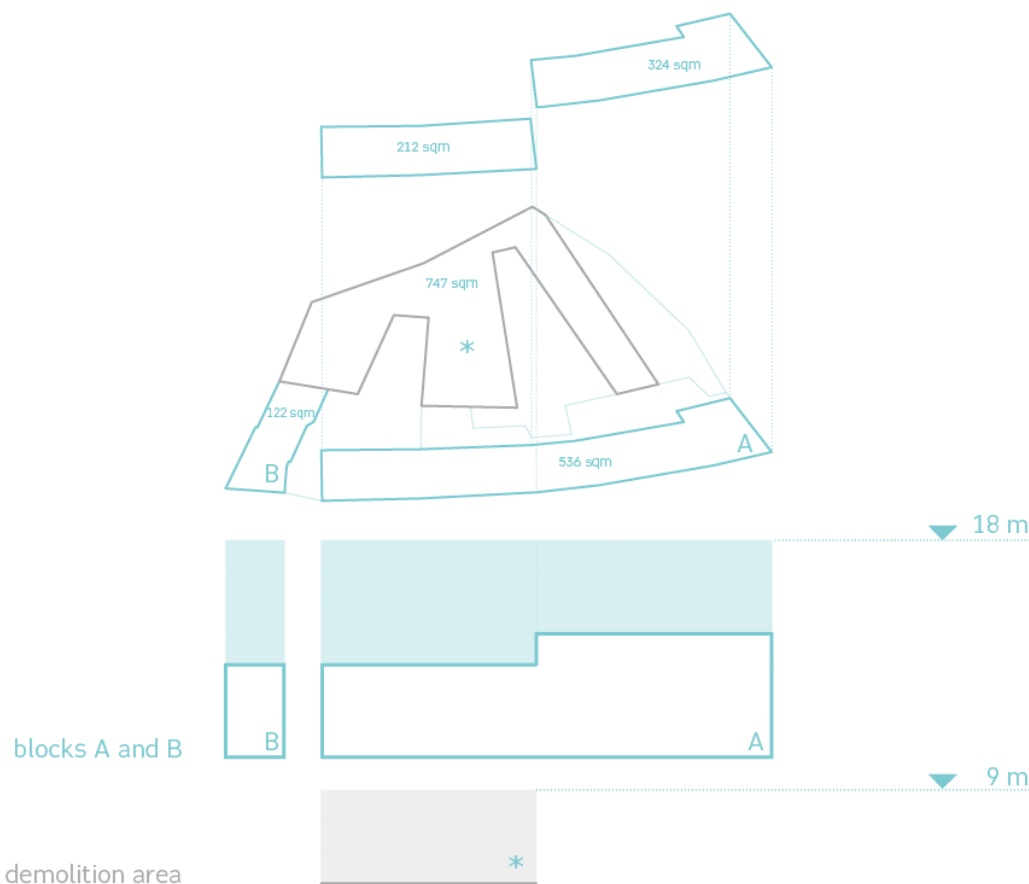

Figure 7.4 Maximum surfaces and heights of rooftop additions on blocks A and B and new constructions in demolition area (source: author)



## 7.4 The actual design

The architecture studio owner of the case study has elaborated a design of additions on the existing buildings, including a rooftop addition and assistant buildings.

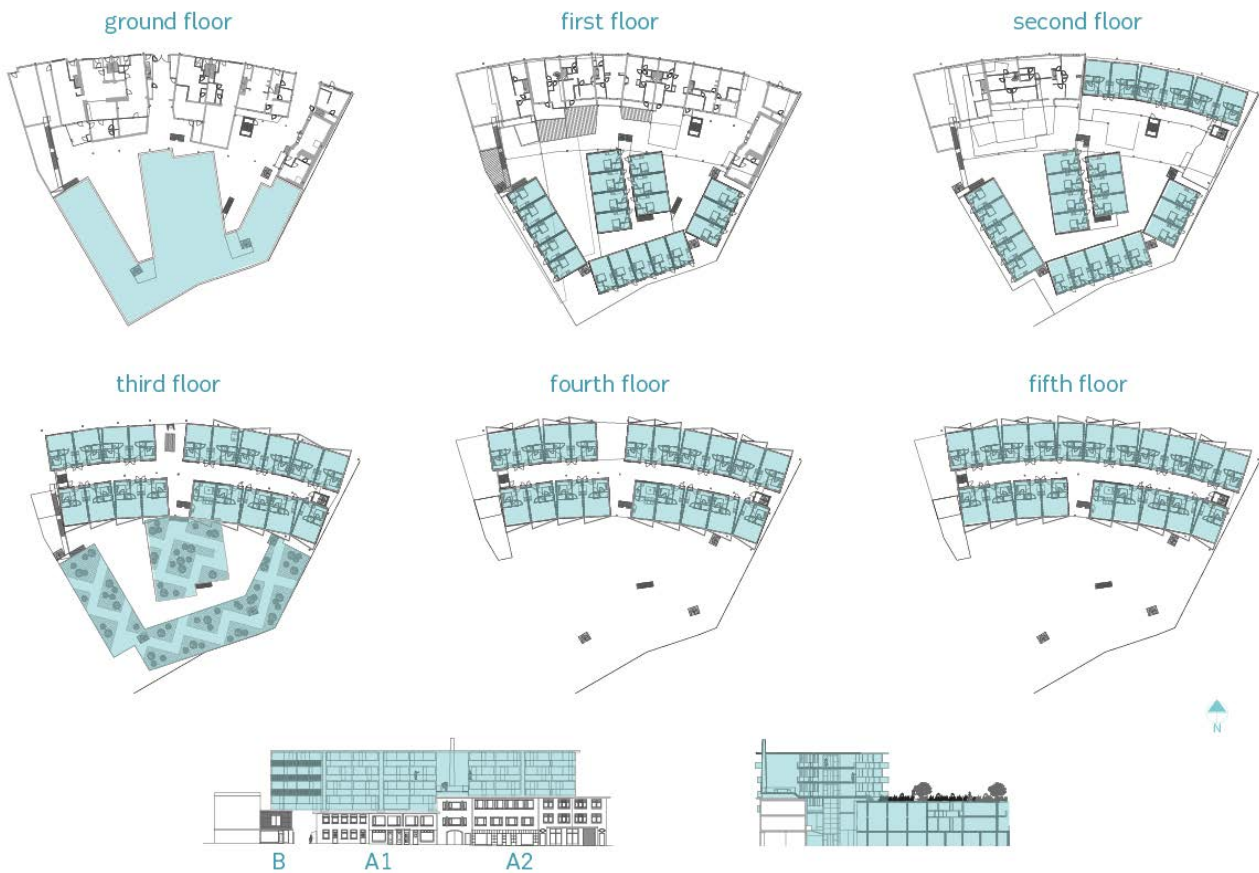

Figure 7.5 Actual project: Urban Climate Architects (source: Urban Climate Architects)

The rooftop additions consist of 64 two-room apartments of about 30 sqm, while the assistant buildings include 40 studios of about 24 sqm. Also the assistant buildings' ground floors are considered to be occupied by about 700 sqm of offices. All the additions are thought to be wooden structures and the rooftop additions are sustained by a steel structure connected to the existing brick wall buildings.

## 7.5 The parameters

The identification of the parameters that play the most important role in defining the add-ons intervention on the case study is relevant to fix the main guide lines for the design phase.

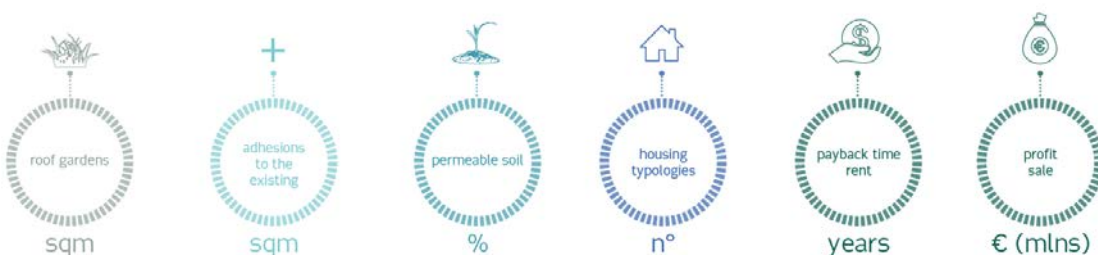

Figure 7.6 Parameters of comparison between the projects (source: author)

The fixed parameters include sustainability measures and approaches and economic aspects: the sqm of roof gardens created, the sqm of adhesions to the existing, the percentage of permeable soil gained, the number of housing typologies, the payback time through the rents and the profit through the sale. In the conclusions, they will be used to quantify the design and evaluate its sustainability and feasibility.

## 7.6 Scenarios of feasibility of the investment

Five different scenarios of add-ons have been obtained in order to counterbalance the investment on the retrofitting of the existing buildings. As the existing buildings have an owner who rents each dwelling to different tenants, the feasibility of the investments has been evaluated considering two options for the owner who invests. The first one is the possibility to increase the rents of the existing dwellings of an amount calculated by using the Points System. This method can be found in the Implementation of Rent Prices Living Space Act which have been revised in 2011 and it determines if a dwelling is in the regulated system and how much rent can be charged. Points are given to different aspects of quality of the dwelling and, for what concerns heating and thermal insulation, the points are related to the energy labels classification. In fact, the increase of the rents has been calculated by adding 40 points for each retrofitted dwelling, considering to change from label G to A++, and adding 1 point per new square meter of adhesion to the existing apartments, as the regulation has established. By evaluating the Points System classification, it has been deducted that each point represents approximately +5.17 euros per month, meaning +62.04 euros per year. Concerning the new dwellings to be rented, the rents have been assumed by using the real estate market values of about 17 euros/sqm per month, meaning 204 euros/square meter per year. The second approach to the investment concerns the sale of the existing buildings with the add-ons after the retrofitting interventions. The renovation, construction and demolition costs per square meter have been given by the Urban Climate Architects, the architecture studio owner of the buildings. About the construction cost, the value of 1,300 euros/sqm has been increased of about 40%, in order to take into account the taxes (21% of VAT) and an estimation of costs concerning the services (19% include calculations, design and planning fees for the parking), obtaining the amount of 1,820 euros/sqm. While, considering the rooftop addition, the construction cost has been increased of 150 euros, with a final value of 1,970 euros/sqm, in order to include the costs related to the modifications on the existing. Moreover, the sale price of the new and existing dwellings have been assumed considering the real estate market values, while the photovoltaic cost has already been calculated in chapter 6.2.

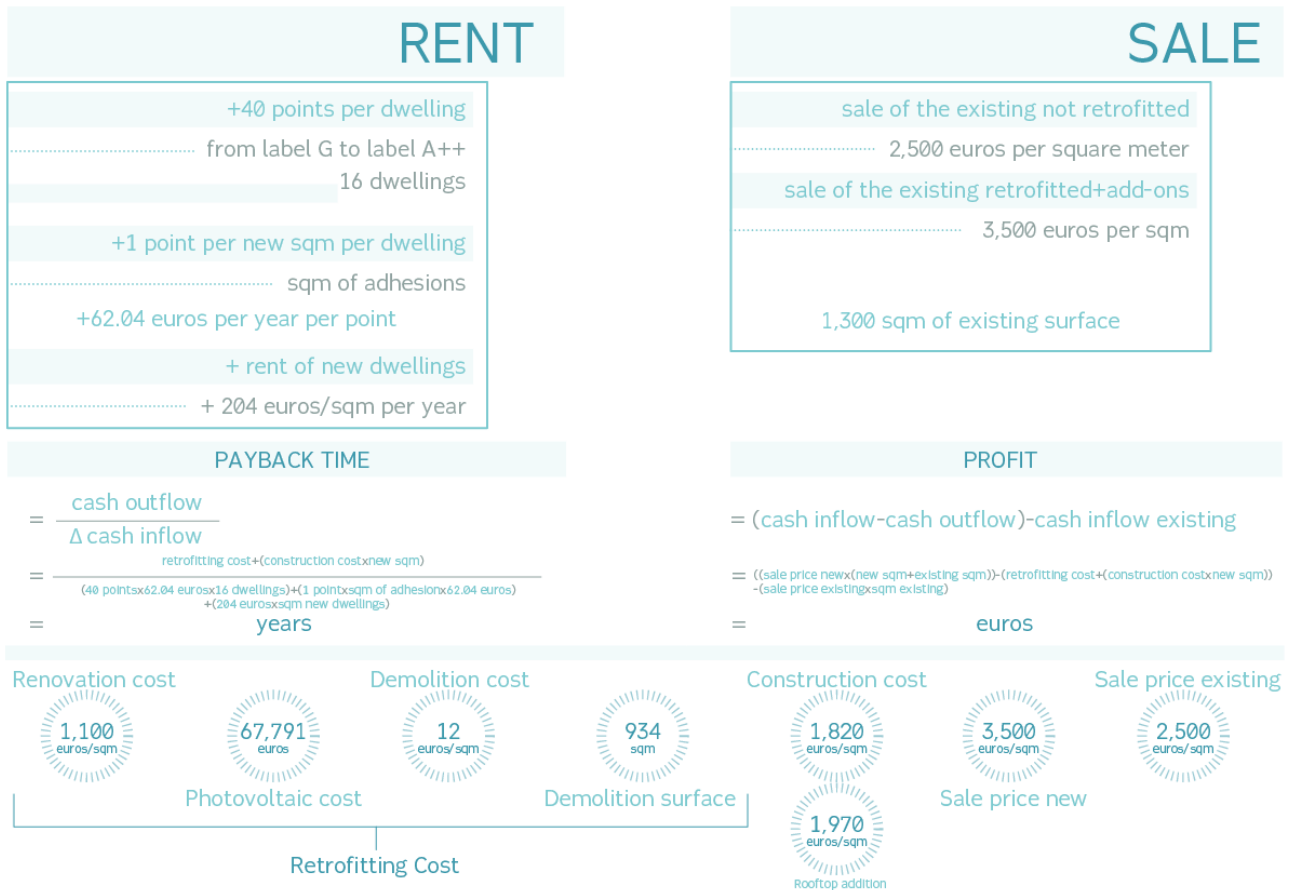
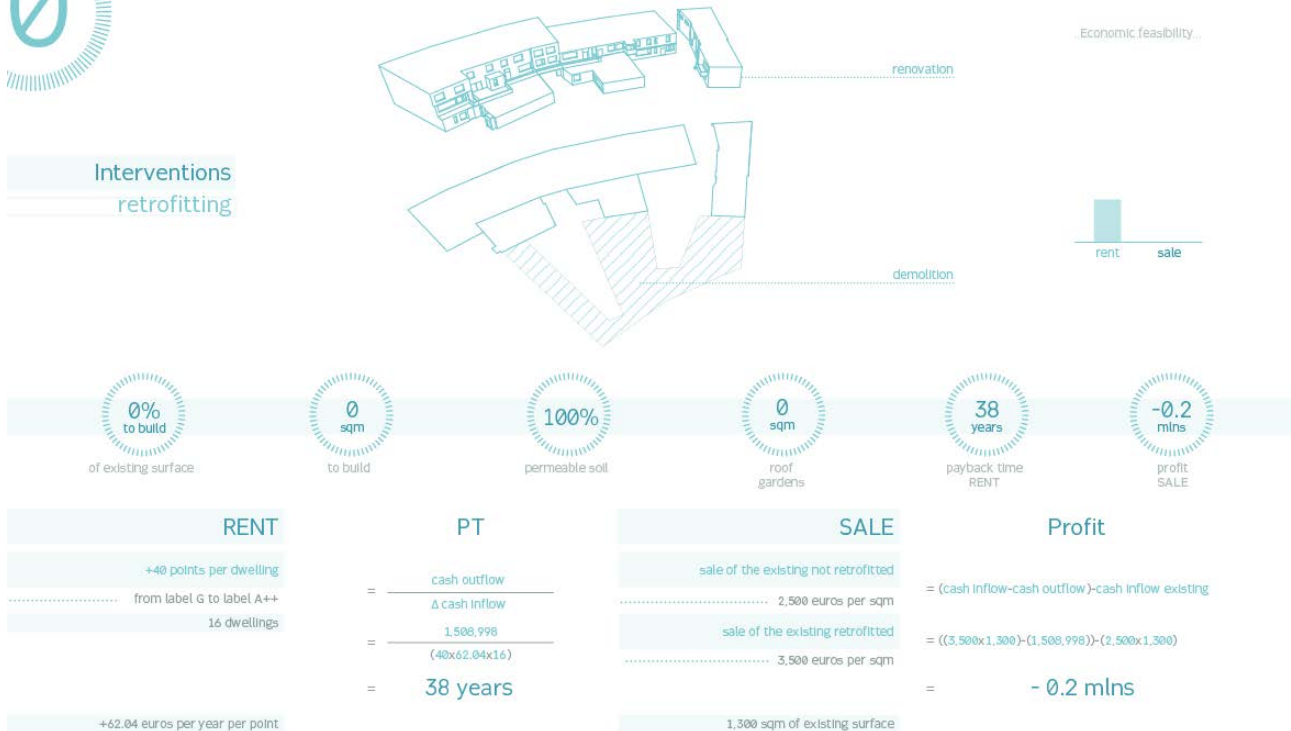

Figure 7.7 Economic values for the scenarios (source: author)

Five different scenarios for the new construction project have been obtained and they are characterised by different quantities in terms of surface to build, permeable soil, payback time through the rents and economic profit from the sale. The scenarios follow the main guidelines drawn by ABRACADABRA: the only retrofitting of the existing, the façade extension, the rooftop addition and the assistant building, while the addition on the side of the existing is not considered due to lack of space.

The volumetric additions considered in the scenarios are only assumptions of amounts of surfaces to add to the existing ones and no specific design details are provided yet, since this will be stated later.

## 7.6.1 Scenario zero Retrofitting



The scenario zero only considers the retrofitting of the existing buildings. This possibility is presented in order to establish the starting point of the process and to validate the effectiveness of the add-ons strategy. By considering an increase in the rents, thanks to the energy efficiency improvements, the payback time of the investment is about 38 years. Instead, the profit obtained by the sale of the retrofitted existing buildings, is about -209,000 euros. This means that it is more profitable to sell the existing buildings as they are, rather than retrofitting them and then sell them. For this reason, the add-ons are required in order to make the interventions feasible and fruitful for the owner.

## 7.6.2 First scenario

# Adhesions

# 1

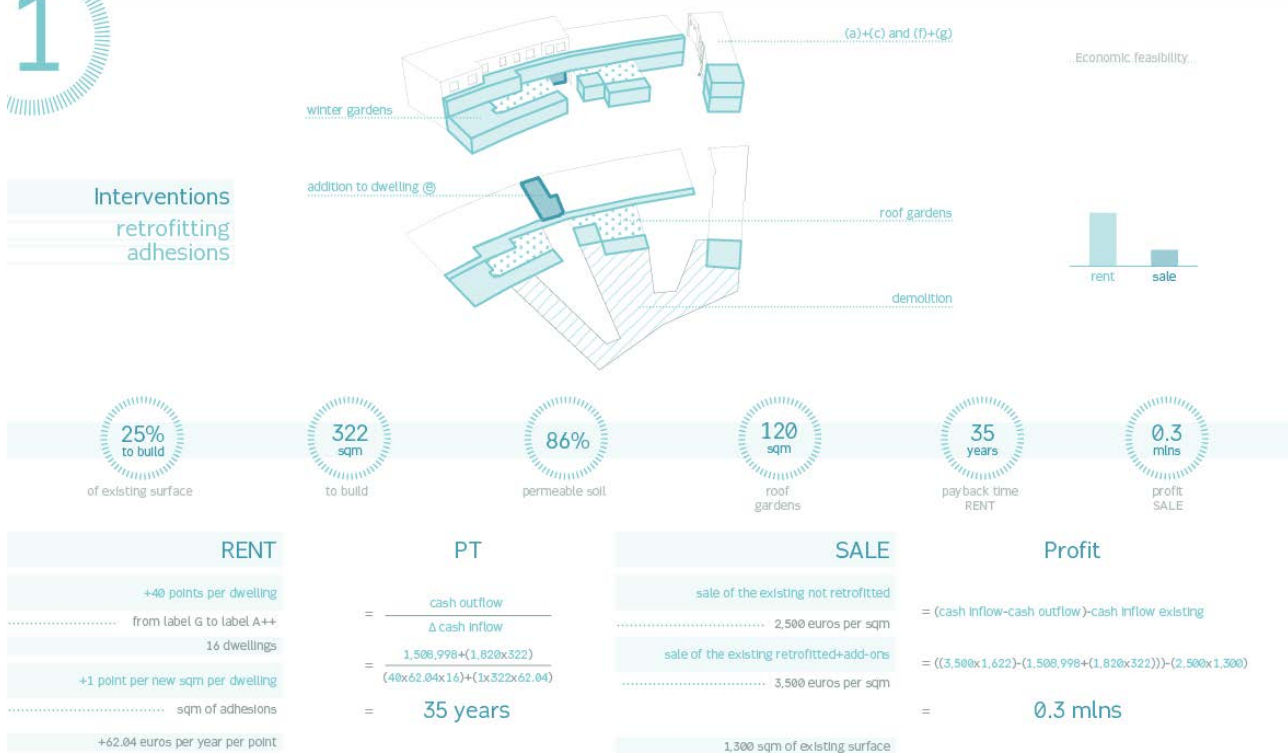

Figure 7.8 First scenario: adhesions (source: author)

The first scenario considers the construction of adhesions on the south façade of the existing blocks. These are seen as extensions of the existing dwellings in order to increase their useful surface and increase their solar gains, as the adhesions are thought to be winter gardens with glass shells. Moreover, the useful surface of dwelling (e) is increased by adding to it the external space next to the kindergarten, by closing it with glass walls. Furthermore, in block B, dwellings (a) and (c) at the ground floor and (f) and (g) at the first floor are respectively joined in order to create bigger apartments with inner cross ventilation and exposure towards south. Therefore, the interventions considered consist of the retrofitting of the existing blocks and the construction of the adhesions with 322 sqm to build and 86% of permeable soil, thanks to the demolition of 747 sqm. Moreover, 120 sqm of roof gardens are gained by covering the existing ground floor's roofs. By considering an increase in the rents, thanks to the energy efficiency improvements and to the extension of the existing dwellings, the payback time of the investment is about 35 years. Instead, the profit obtained by the sale of the retrofitted existing buildings with the adhesions, is about 300,000 euros.

## 7.6.3 Second scenario Rooftop additions



Figure 7.9 Second scenario: rooftop additions (source: author)

The second scenario consists of the construction of three floors of rooftop additions on both blocks A and B, reaching the maximum permitted height of 18 meters on part of block A (A2). The elevator and stairs are situated between the two existing blocks, also in order to highlight the entrance and fill the existing gap. The retrofitting of the existing is followed by the construction of 2,100 sqm of additions, the demolition of 747 sqm and the consequent achievement of 98% of permeable soil. By considering an increase in the rents of the existing dwellings, thanks to the energy efficiency improvements and the income obtained through the rents of the new dwellings, a payback time of about 12 years is obtained. It must be reminded that, considering the rent, a payback time of less than 15 years is considered acceptable. Instead, the profit obtained by the sale of the retrofitted existing blocks with the new rooftop additions, is about 3 millions of euros.

### 7.6.4 Third scenario

## Adhesions+Rooftop additions+Assistant building

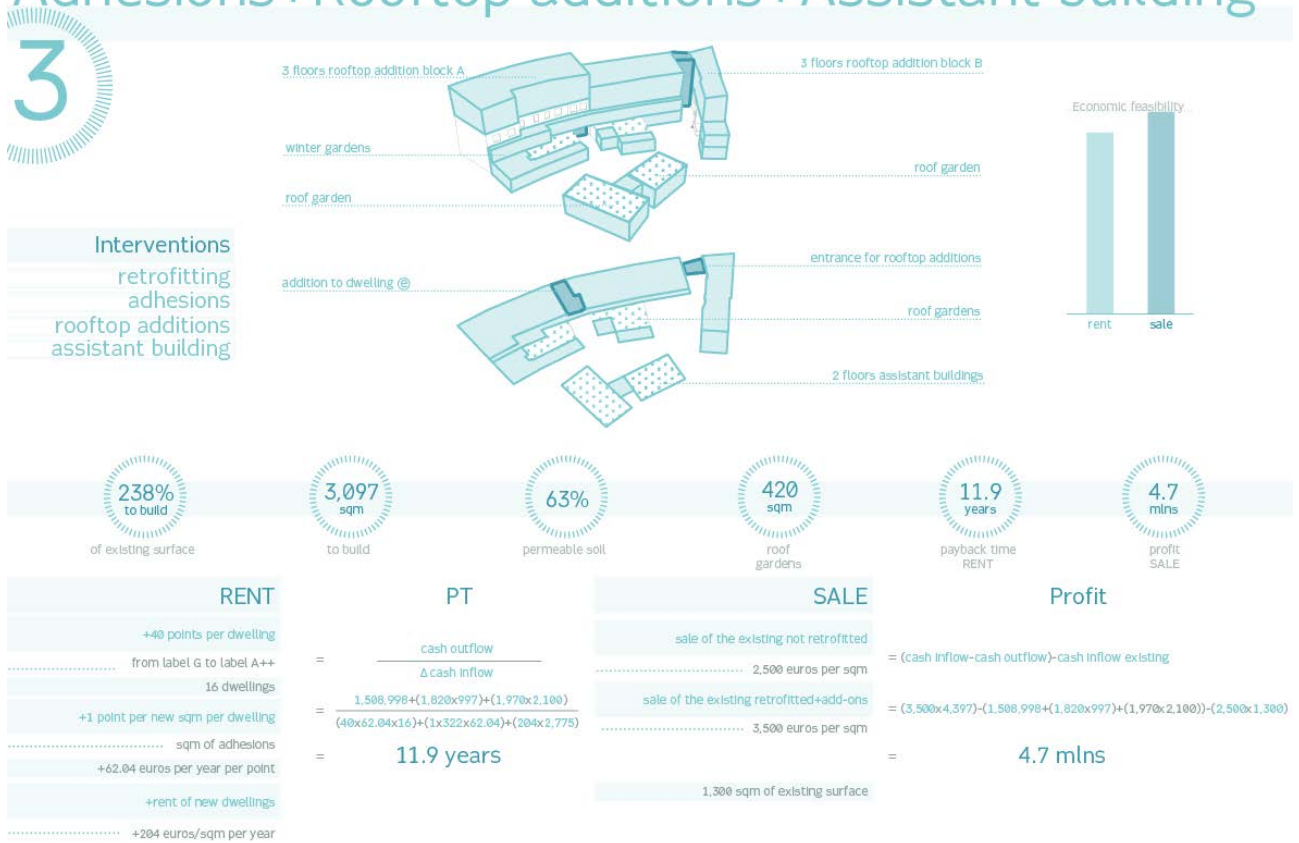

Figure 7.10 Third scenario: adhesions, rooftop additions and assistant buildings (source: author)

The third scenario consists of the combination of the adhesions with the rooftop additions and two assistant buildings of two floors situated in the southern part of the block. These buildings are made of the same wooden structure as the rooftop additions with a total useful floor area of 675 sqm. As a consequence, the total surface to build is about 3,097 sqm and the permeable soil is about 63%. Not only the ground floor's roofs of the existing buildings are covered by roof gardens, but also the assistant buildings' roofs, with a total green roofs' area of about 420 sqm. By considering an increase in the rents, thanks to the energy efficiency improvements, the extension of the existing dwellings and the income obtained through the rents of the new dwellings, the payback time of the investment is about 11.9 years. Instead, the profit obtained by the sale of the retrofitted existing buildings with the add-ons, is about 4.7 millions of euros.

## 7.6.5 Fourth scenario

# Rooftop additions+Assistant building

# 4

### Interventions

- retrofitting
- adhesions
- rooftop additions
- assistant building

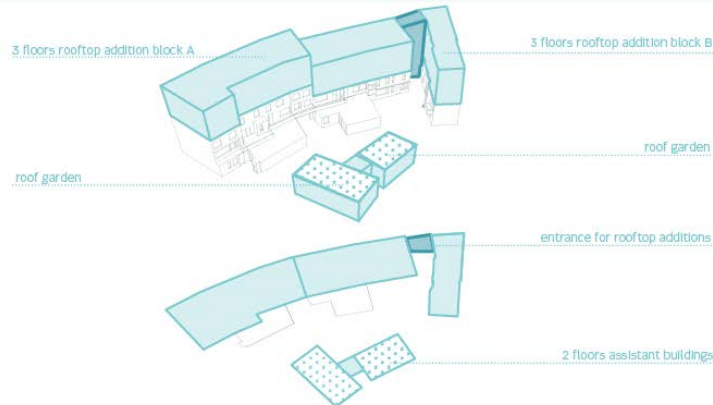

RENT	PT	SALE	Profit
+40 points per dwelling from label G to label A++ 16 dwellings		sale of the existing not retrofitted 2,500 euros per sqm	= (cash inflow-cash outflow)-cash inflow existing
+1 point per new sqm per dwelling sqm of adhesions	= $\frac{\text{cash outflow}}{\Delta \text{cash inflow}}$	sale of the existing retrofitted+add-ons 3,500 euros per sqm	= (5,300x4,075)-(1,508,998+(1,820x675)+(1,970x2,100))-(2,500x1,300)
+62.04 euros per year per point	= 11.3 years	1,300 sqm of existing surface	= 4.1 mlns
+rent of new dwellings +204 euros/sqm per year			

The fourth scenario consists of the combination of the rooftop addition with the two assistant buildings of two floors situated in the southern part of the block. The total surface to build is about 2,775 sqm and the permeable soil is about 75%. The assistant buildings' roofs are covered by gardens with a total area of about 300 sqm. By considering an increase in the rents, thanks to the energy efficiency improvements and the income obtained through the rents of the new dwellings, the payback time of the investment is about 11.3 years. Instead, the profit obtained by the sale of the retrofitted existing buildings with the add-ons, is about 4.1 millions of euros.



		TO BUILD				
		sqm	%	sqm	years	€ (mlns)
		0	100	0	38	-0.2
		322	86	120	35	0.3
		2,100	98	0	12	3
		3,097	63	420	11.9	4.7
		2,775	75	300	11.3	4.1

Table 7.6 Summary data from the scenarios (source: author)

The quantities for each scenario have been put in a summary table in order to highlight the maximum achievements for each parameter. It can be stated that scenario 3 (adhesions, rooftop additions, assistant buildings) has the maximum square meters to build. As for the maximum permeable soil gained, scenario 2 (rooftop additions) has the highest percentage. The lowest payback time through the rents is obtained with scenario 3, while the highest profit through the sale is obtained with scenario 4 (rooftop additions, assistant buildings).

## 7.7 Master plan

### 7.7.1 Demolition

The choice of demolishing the three buildings located inside the block has been made evaluating different motivations. Firstly, the data available for those buildings was scarce, only floor plans were available and, thanks to the historical archives, it was known that the original structure was made of masonry, wood and steel profiles. Moreover, it was known that probably they were used as warehouses, so they were unheated spaces. Due to these reasons, they were not taken into account in the energy demand calculations. These reasons caused the impossibility to add value to the existing buildings, so it was decided to build a new one that could give shape to a new dynamic and well organised living environment.

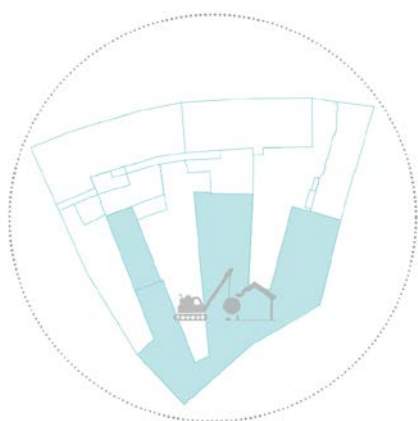

Figure 7.11 Demolition area (source: author)

### 7.7.2 Plan

The last cost-benefit scenario gives the possibility to reach a consistent quantity of new surfaces to build and gain permeable soil. The design phase has the objective to show a possible scene plot of how the construction process could be carried on, in fact the third cost-benefit scenario has been chosen so that adhesions, rooftop additions and assistant buildings can be presented. Firstly, it is important to underline that more than half of the total not built surface has been converted into permeable soil and 420 sqm have been used to create roof gardens on the existing ground floors' and assistant buildings' roofs. The design of the assistant buildings follows the fan shape of the case study site. The green areas are divided into private areas for the existing dwellings and public areas to be used by all the inhabitants and the main route connects the entrance with the assistant buildings.

About the different types of trees put in the new green area, two have been chosen: the maple and the ash tree. Both have deciduous leaves, meaning that in summer they have a dense and large foliage, while in winter they lose the leaves. For this reason they have been chosen and put along the south perimeter, so that in summer they can give shadow to the winter gardens during the hottest hours, while in winter they do not obstacle the sun rays, allowing the warming of the south facing surfaces. Moreover, the maple tree is also known for its beauty during the autumnal season, as its leaves change colour ranging from green to pink and red and then yellow, before falling. In addition, different types of bushes have been added in order to sign the property borders of each private garden. Deciduous leaves trees have been used also to divide the properties between the existing dwellings and the assistant buildings along the main route.

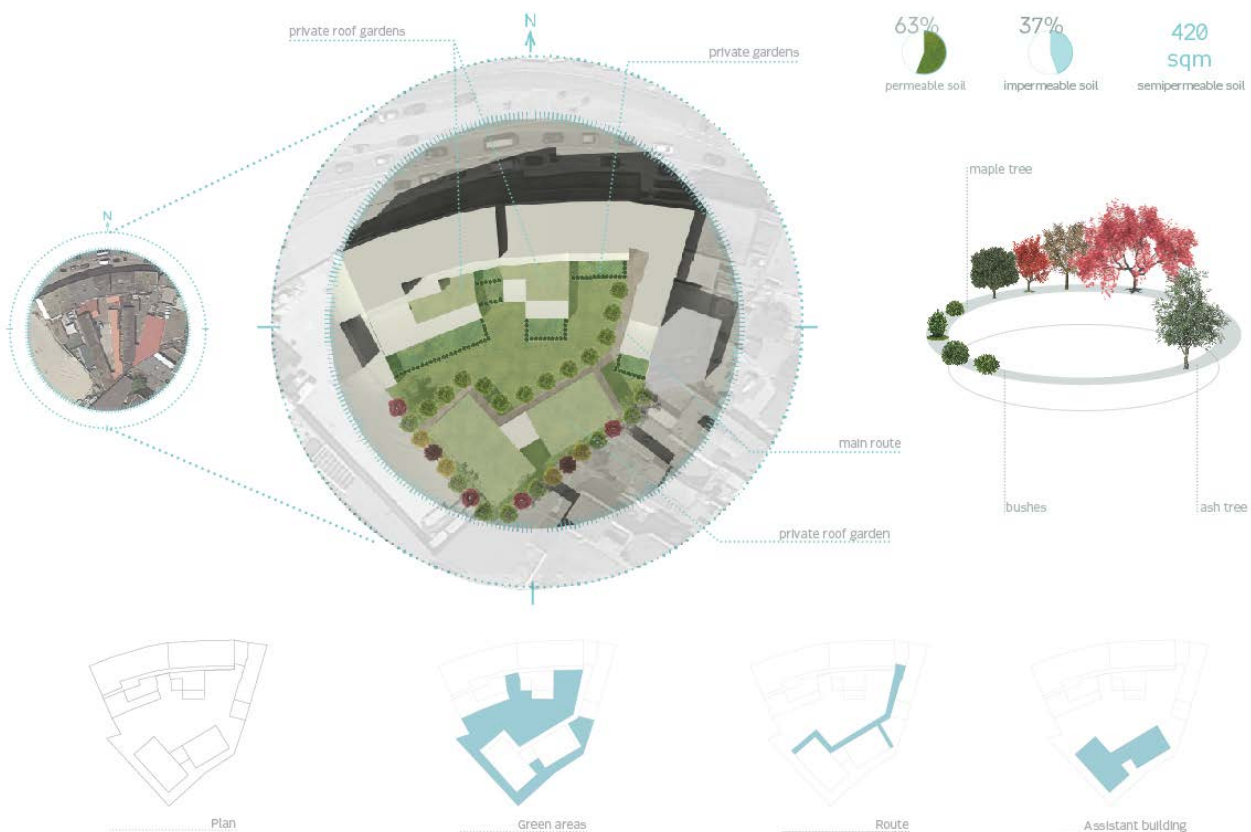

Figure 7.12 Master plan: before and after the intervention, percentages of permeable, impermeable and semipermeable soil, type of trees and bushes, evolution of the concept (source: author)

The position and shape of the assistant building have been chosen by taking into account different restrictions. Firstly, the building had to be constructed in the south part of the block with a maximum height of nine meters. Moreover, there was the need to preserve the solar lighting to the existing and new constructions. As also the economic profit had to be considered, the surface extension had to be maximized and, as a consequence, permeable soil was lost. Because of this, the assistant building's roof was thought as a garden. As a result, two blocks of two floors each have been designed, connected by the main entrance block. The orientation of the buildings follows the fan shape of the block and marks the block's borders.

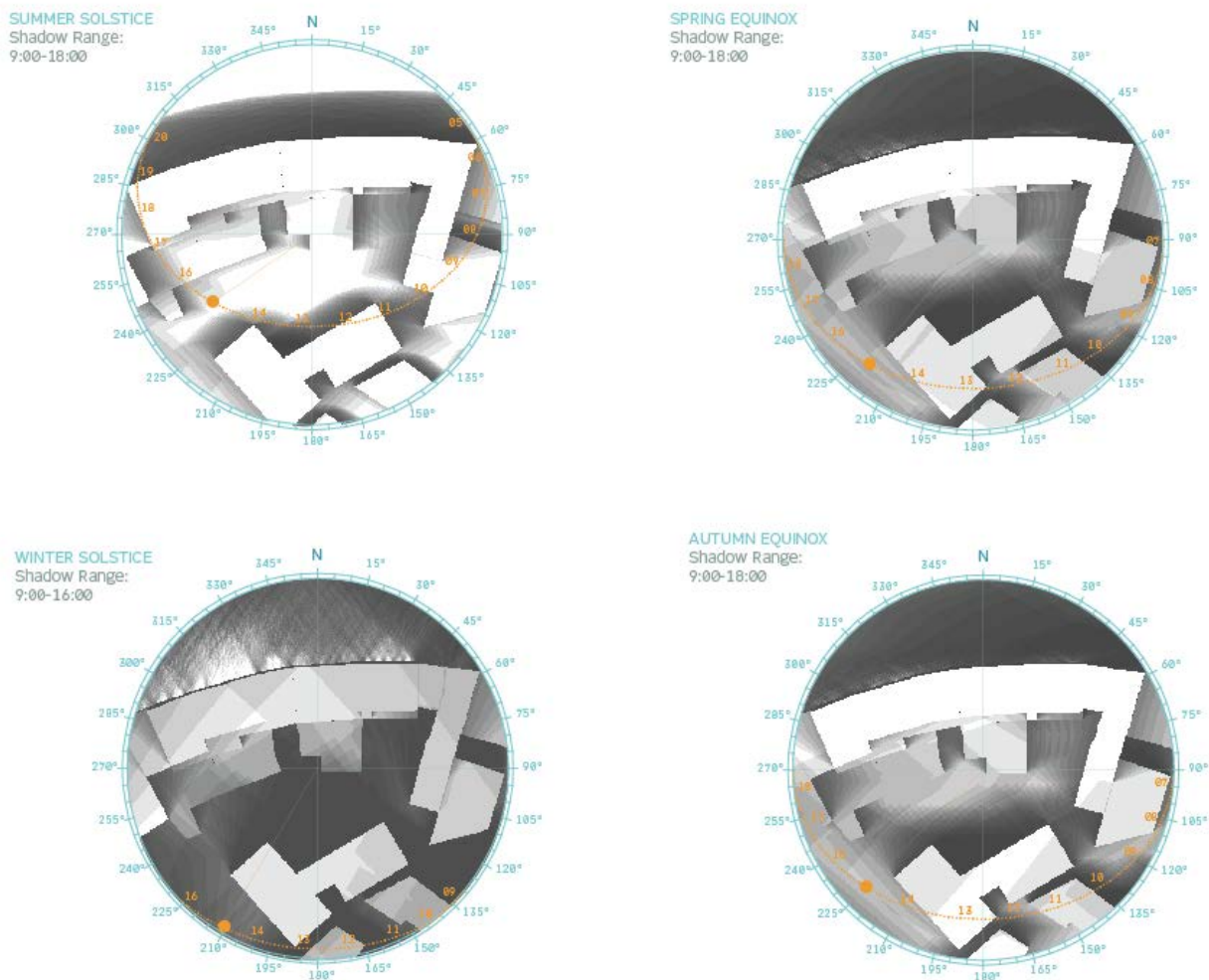

Figure 7.13 Different shading scenarios following the seasons (source: author; software: Autodesk Ecotect Analysis)

By evaluating the shadow ranges during the different seasons, it can be stated that the design of the assistant buildings minimizes the shading on the existing constructions and the adhesions and rooftop additions, above all in winter, when the sun is low in the sky and there is more need of solar gains because of the low temperatures.

## 7.8 Proposal

### 7.8.1 Wooden structure

The entire structure of the add-ons is made of wood. Glue laminated timber (GLT) has been chosen for the columns and beams, while cross laminated timber (CLT) has been chosen for

the walls, roofs and floors. Cross laminated timber is a structural two-way spanning timber panel created by laminating and connecting soft wood timber lamellas at 90° to the layer below, while glued laminated timber, also known as glulam, comprises a number of layers of dimensioned timber, bonded together with durable and moisture-resistant adhesives.

Wood is a sustainable and reversible building material that stores, rather than emits, carbon dioxide. Moreover, it allows to create prefabricated elements, such as wall panels and floors, so that the entire construction process would be faster.



*Figure 7.14 Cross and Glue laminated timber (source: [www.kirhammond.wordpress.com](http://www.kirhammond.wordpress.com))*

The tallest building created with this technique is the UBC's Brock Commons Student Residence, which will be completed in May 2017, with a 53 meters height, a concrete podium and two concrete cores, with 17 storeys of cross laminated timber floors supported on glue laminated wood columns.



*Figure 7.15 UBC's tall wood building, Brock Commons (source: [www.news.ubc.ca](http://www.news.ubc.ca))*

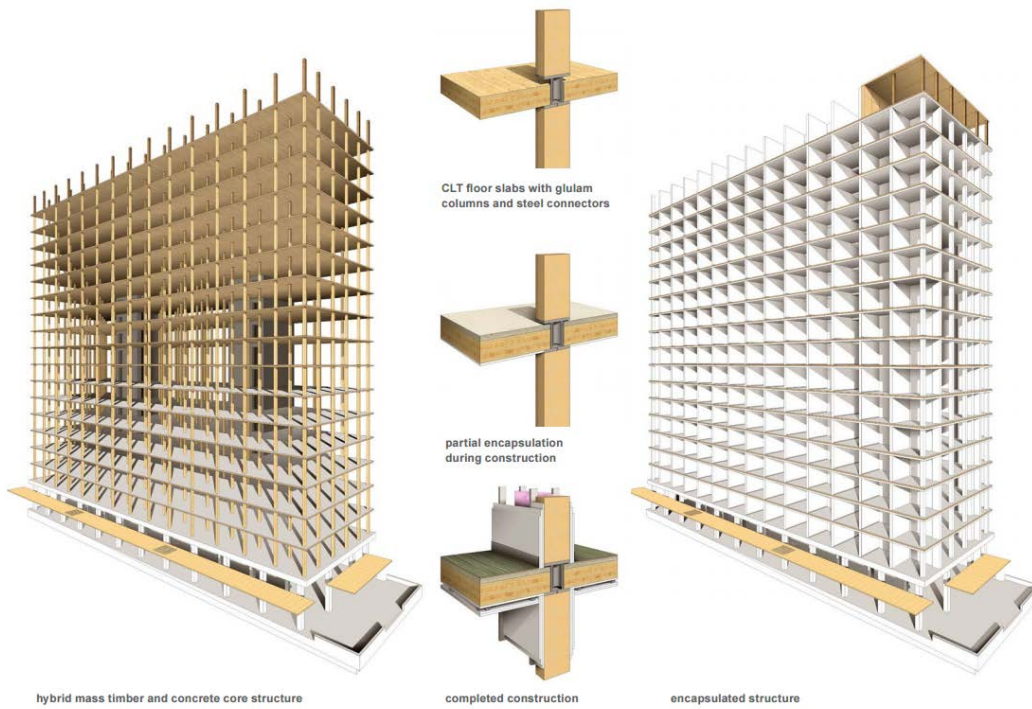

Figure 7.16 UBC's wooden structure and gypsum boards encapsulation (source: [www.hermann-kaufmann.at](http://www.hermann-kaufmann.at))

In particular, the wooden structure has been encapsulated with gypsum layers in order to respect the fire protection regulation.

The first change to show in the new floor plans is the addition of the thermal coat to the existing walls. Moreover, in order to sustain the rooftop addition, steel box shape pillars 220x220 mm have been arranged around the existing perimeter and connected to the existing cross walls. The pillars and the existing walls sustain a table of steel beams that carries the load of the rooftop new dwellings.

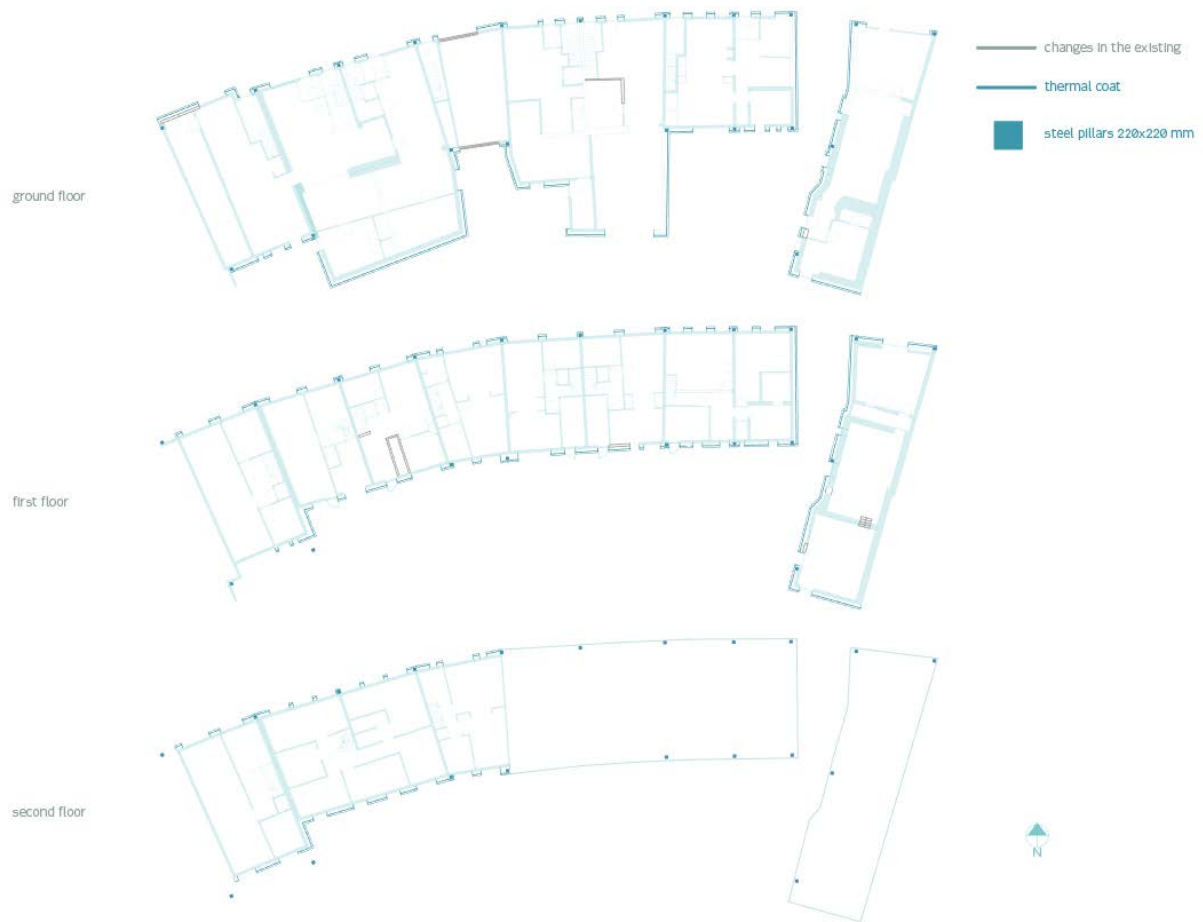

Figure 7.17 Thermal coat addition and steel pillars to sustain the rooftop addition: ground, first and second floor (source: author)

In order to hide the steel pillars of the support structure, the thermal coat's wood fiber thickness has been increased from 10 to 22 cm.

### 7.8.2 Winter gardens

The first step of the design process is the composition of the winter gardens in adhesion to the existing retrofitted buildings. In particular, each dwelling has gained more useful surface thanks to the adhesion of the winter gardens. Moreover, concerning dwelling (e), it was not possible to add a winter garden, but more surface was gained by closing the in-between space next to the kindergarten. In addition, dwellings (a) and (c), and (f) and (g), have been joined in order to obtain only two bigger apartments with cross inner ventilation and south exposure and dwelling (f+g) have been provided with new external stairs to connect the ground floor with its entrance.

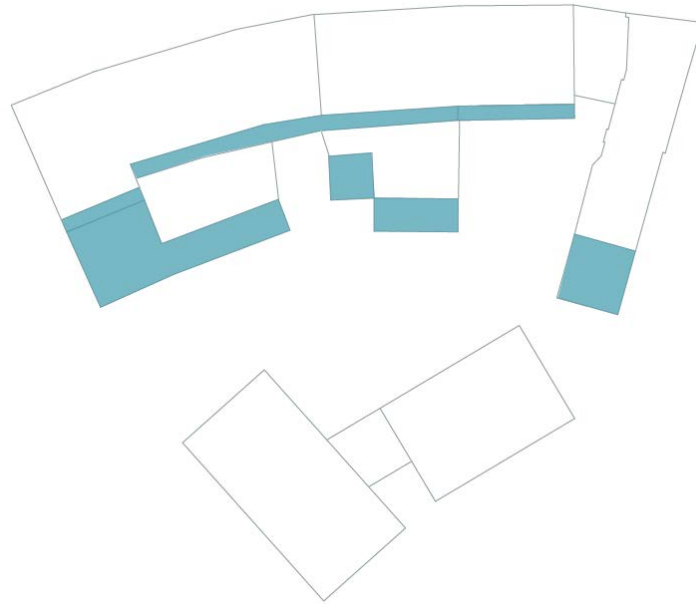

Figure 7.18 Scheme of the new volumes: winter gardens (source: author)

At the ground floor, the adhesion for the kindergarten is a 92 sqm winter garden, the one for dwelling (e) is a 40 sqm surface obtained by closing the open space between the dwelling and the entrance for dwelling (o). Moreover, dwelling (b) and the bar have an added surface of respectively 16 and 23 sqm. Finally, dwelling (d) has an added surface of 25 sqm and dwelling (a+c) have an added surface of 32 sqm. In addition, new stairs have been designed to replace the existing ones connecting the exterior to the entrance of dwelling (f+g) at the first floor (block B).

At the first floor, dwelling (l) has an added surface of 18 sqm, dwelling (m) of 14 sqm with a garden gained from the kindergarten ground floor's roof, of 30 sqm, and dwelling (p) has an added surface of 16 sqm and a garden of 27 sqm. Moreover, dwelling (o) has an added surface of 14 sqm, dwelling (n) of 15 sqm with a garden, gained from dwelling (b) ground floor's roof, of 16 sqm, dwelling (h) has an added surface of 15 sqm and a garden of 32 sqm, while dwelling (i) has an added surface of 25 sqm and dwelling (f+g) have an added surface of 32 sqm.

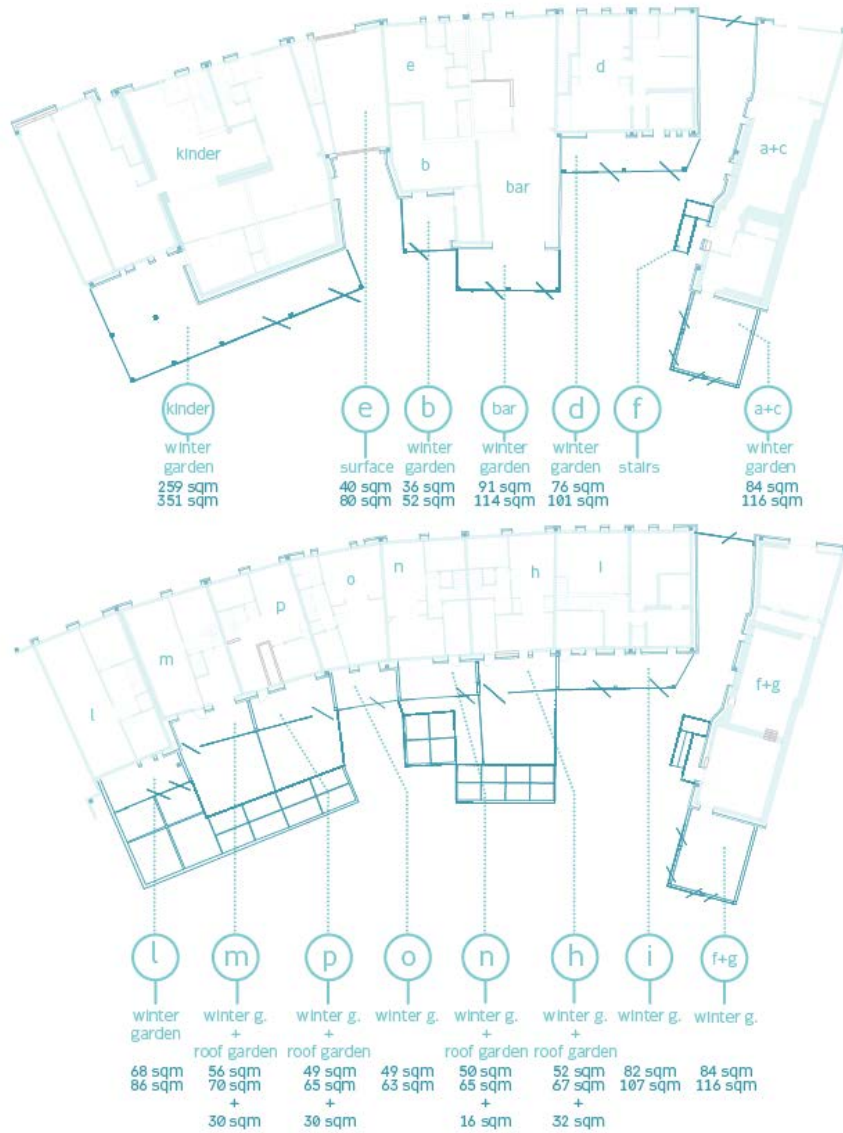
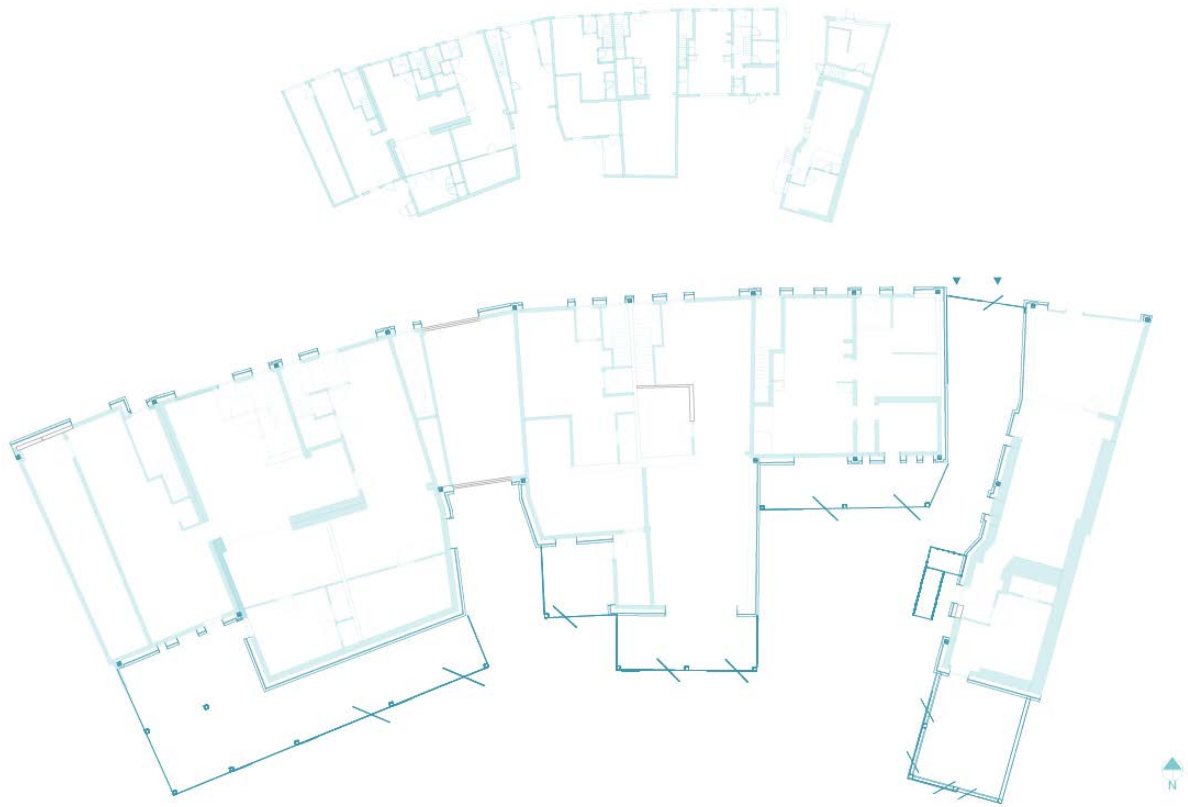

Figure 7.19 Scheme of the adhesions to the existing dwellings: before and after dimensions (source: author)

At the ground floor, some changes have been done when there were no connections with the exterior. In particular, the external walls of the bar and of dwelling (a) have been changed by creating openings to connect with the new winter gardens. Moreover, in order to connect dwellings (a) and (c), the existing staircase has been removed.





*Figure 7.20 Ground floor plan: before and after the intervention (source: author)*

At the first floor, openings have been created in dwellings' (l), (o) and (f) walls in order to connect the existing spaces with the new winter gardens.



Figure 7.21 First floor plan: before and after the intervention (source: author)

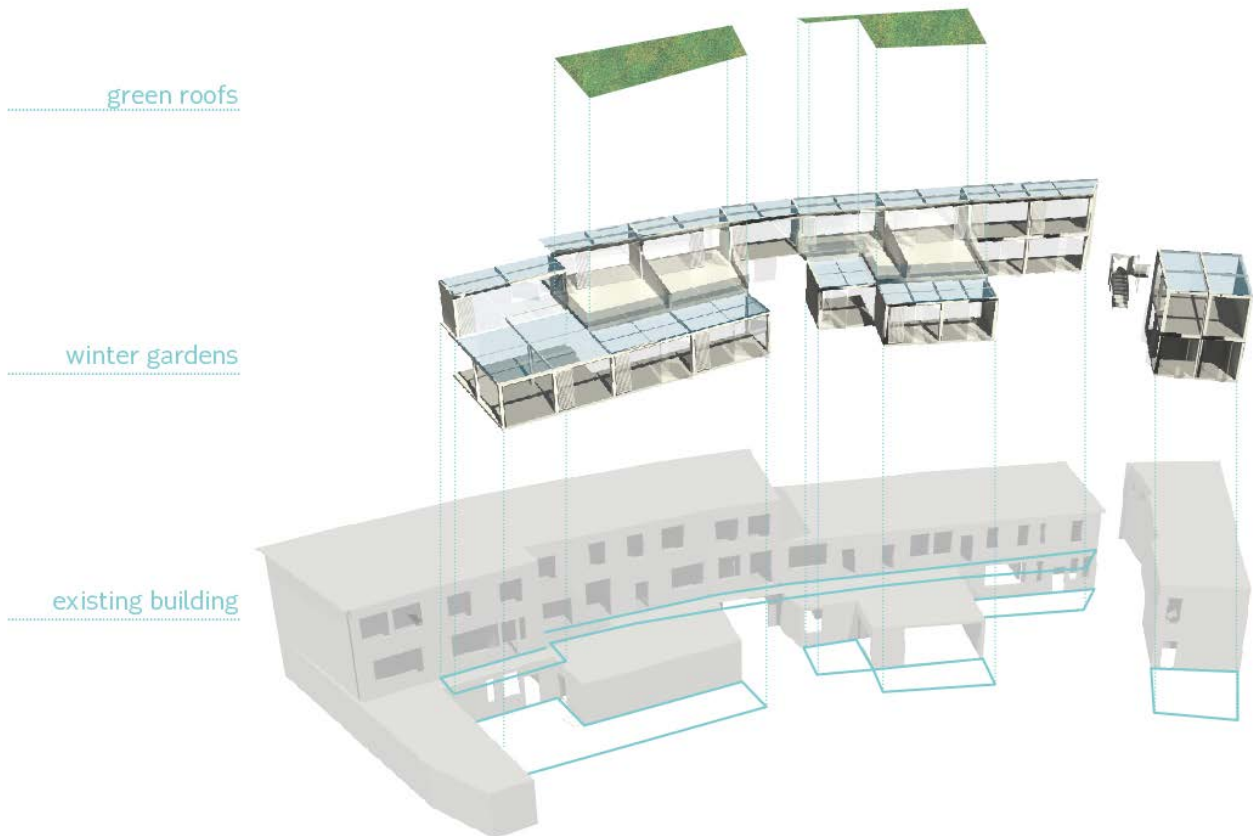

Figure 7.22 Composition scheme of the new volumes (source: author)

As the prefabrication process is assumed to be used, each component is thought to be already assembled and then brought to the construction site. The winter garden module is composed by a structure of glue laminated timber columns and beams anchored to the existing masonry walls. The entire structure is covered by a shell of glass walls and openings with no frames. Wooden frames are used to cover the inner part of the wooden structure and a photovoltaic glass grid is used as a roof. Moreover, movable brise soleil are added to the exterior part of the shell, while some glass sides of the winter gardens are completely covered by unmovable brise soleil wooden listels in order to gain privacy from the neighbourhood. In addition, a groove along the perimeter of the winter garden is used as rainwater drainpipe.

The new stairs for the connection of dwelling (f+g) to the ground floor are sustained by wooden columns reinforced by a steel bracing. The steps are made of perforated flat steel profiles, while the external handrail is made of glass and the inner one is made of steel panels.

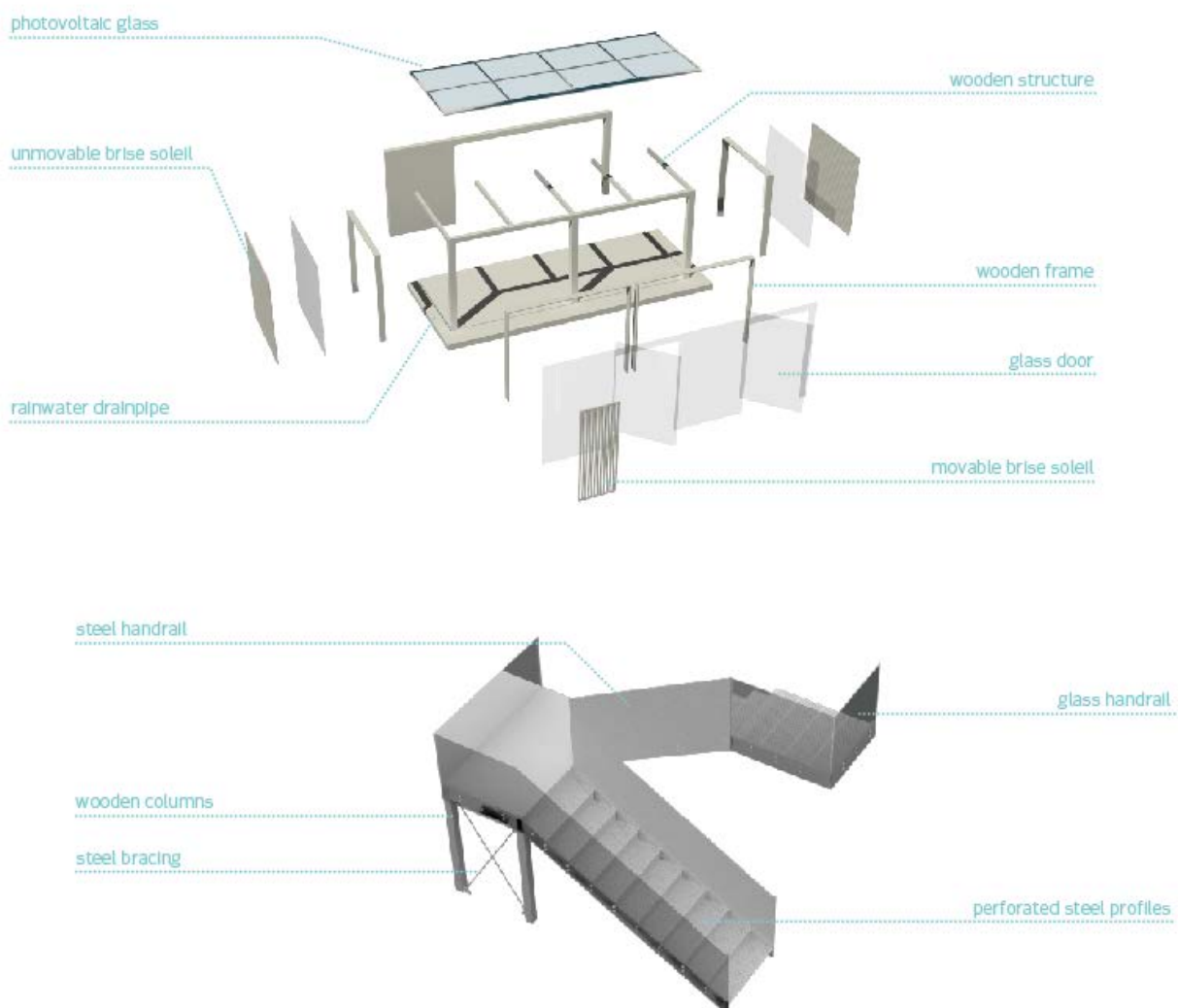

Figure 7.23 Winter garden module and external stairs for dwelling (f) (block B) (source: author)

There are two types of brise soleil, one is used to give shade during the warmest hours and is made of a wooden grid of listels that can be moved along the glass wall. The other is

unmovable and covers entirely some sides of the winter gardens in order to provide privacy from the neighbourhood.



Figure 7.24 Location of movable and unmovable brise soleil: ground and first floors (source: author)

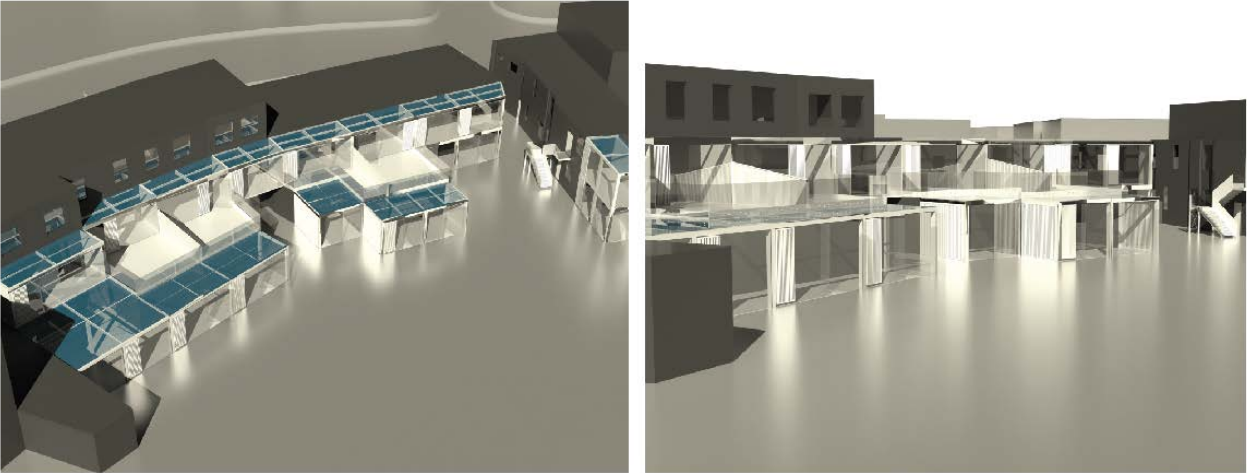

Figure 7.25 Renders (source: author)

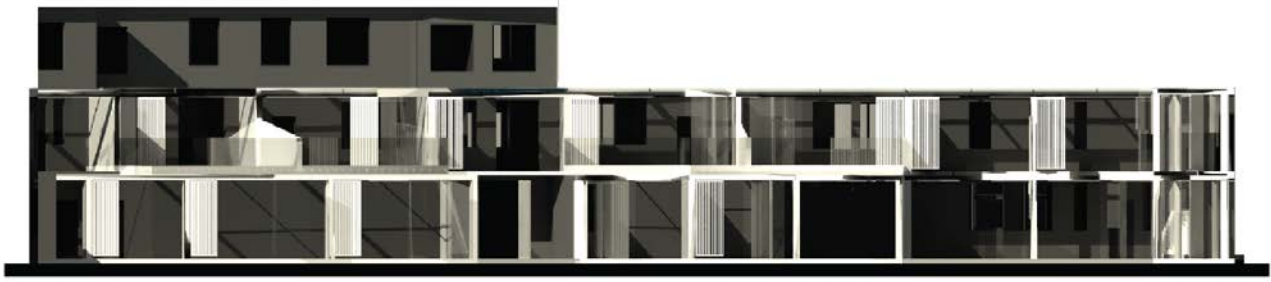

Figure 7.26 South facade view: winter gardens (source: author)

### 7.8.3 Rooftop additions

The third scenario proposes a rooftop addition of three new floors on both block A and B by maintaining the existing difference in height of block A's buildings.

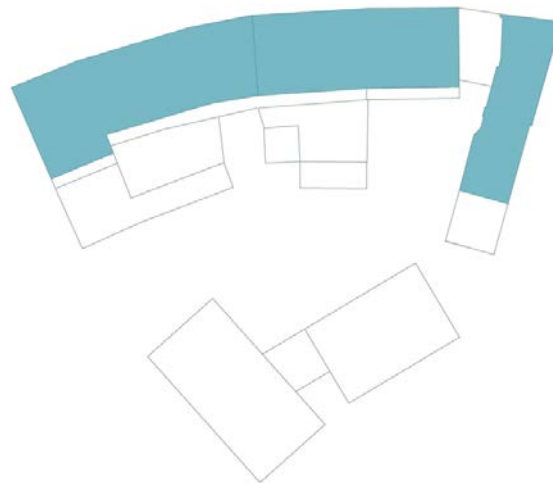

Figure 7.27 Scheme of the new volumes: rooftop additions (source: author)

The two rooftop additions on block A and the one on block B have all the same structure, a wooden skeleton made of glue laminated timber pillars (40x40 cm) and beams (30x40 cm) and cross laminated timber floors, roofs and walls. The spans between the pillars are 4 and 4.9 meters in the transversal direction and 4.5 in the longitudinal direction. The glue and cross laminated timber structure of the additions is also composed by cross laminated timber panels in both transversal and longitudinal direction, with a bracing function in order to resist the horizontal forces such as wind. Moreover, as the south façade is entirely composed by glazing and openings, steel bracing portals have been added in order to reinforce the wooden skeleton. In order to sustain this structures, steel box shape pillars 220x220 mm filled with reinforced concrete have been put around the perimeter of the existing buildings, aligned and connected to the crossing brick walls in order to cancel the moment and contribute to the function of bracing. The pillars and the existing cross walls sustain a steel table made of steel beams IPE 300, aligned with the existing cross walls, and IPE 160, which support a corrugated steel sheet with reinforced concrete casting (6 cm steel sheet and 8 cm concrete casting)

and transmit the rooftop additions' loads to the lower pillars and walls.

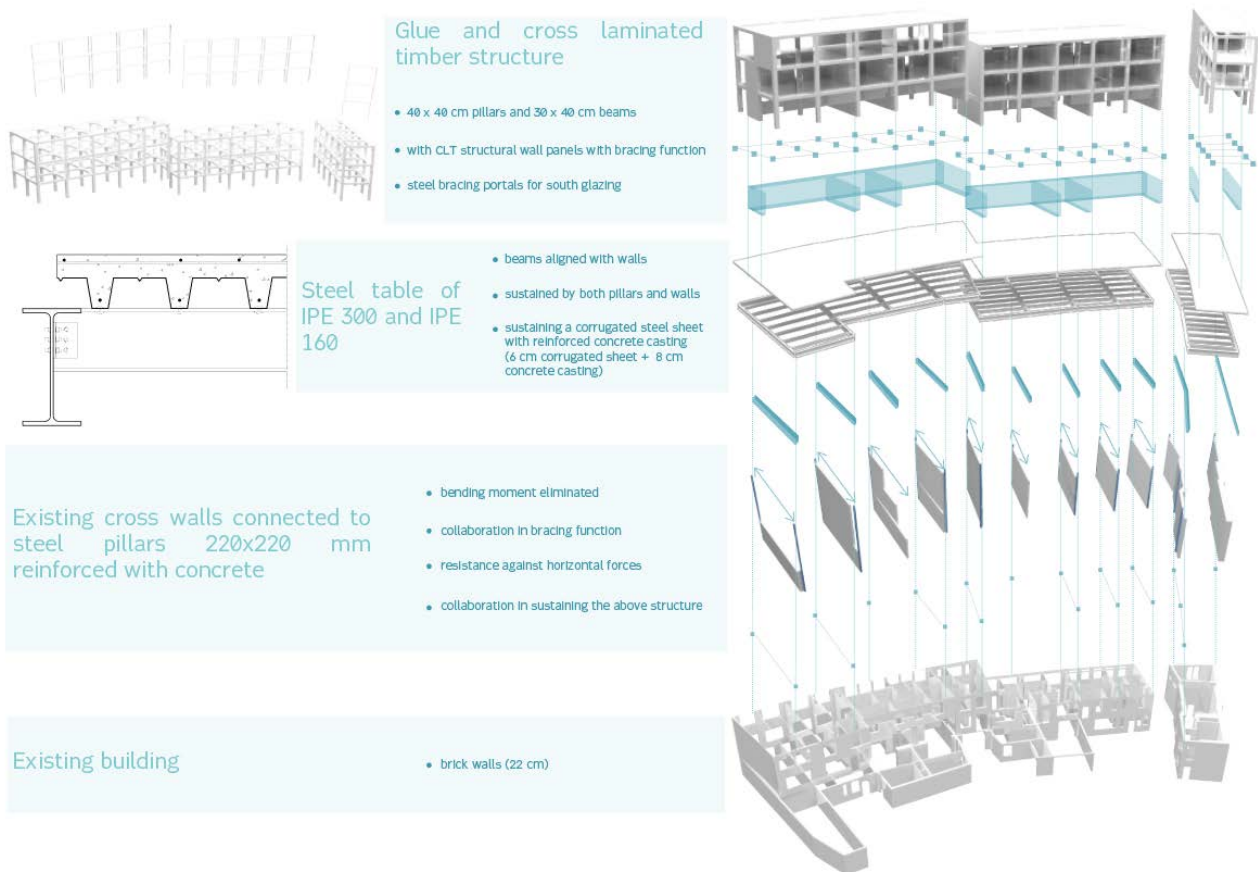

Figure 7.28 Rooftop additions: structure (source: author)

The Netherlands have low seismic activity, the most is located in the south-east part, where also induced seismic activities happen due to oil and gas extraction. The area of The Hague has a Peak Ground Acceleration of  $0.22 \text{ m/s}^2$  ( $0.022 \text{ g}$ ), with a 10% probability of exceedance in 50 years (return period 475 years). Therefore, as the case study lies in a zone with low seismic potential, interventions of adjustment are not required for the existing buildings.

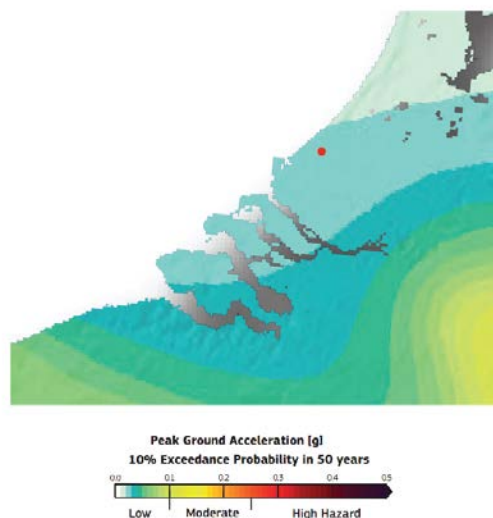

Figure 7.29 Seismic mapping of the Netherlands and The Hague location (source: Seismic Hazard Harmonization in Europe, 2013)



Figure 7.30 Abacus for different family units combinations (source: author)

An abacus has been created in order to make the intervention adaptable and flexible for different types of family units and obtain various façade configurations for block A, thanks to the possibility to add winter gardens and balconies. The chosen family units are four: an elderly couple provided with a one floor apartment of about 50 sqm, a young couple with an two floors apartment of 50 sqm, a single provided with a studio of 25 sqm and a family provided with a two floors apartment of about 100 sqm. As a result, 44 possible combinations have been obtained to fill in the rooftop additions on block A (A1 and A2) with all the family units.



Figure 7.31 Chosen facade composition for blocks A1 and A2 rooftop additions (source: author)

In order to show a possible configuration of the rooftop additions composition, two different combinations have been chosen for block A1, the part with two existing floors, and block A2, the part with three existing floors. Concerning block B, it is not possible to elaborate different configurations for the dwellings composition because it has a fixed long shape that does not allow flexible spaces. In fact, three apartments, one at each floor, have been thought for its composition.

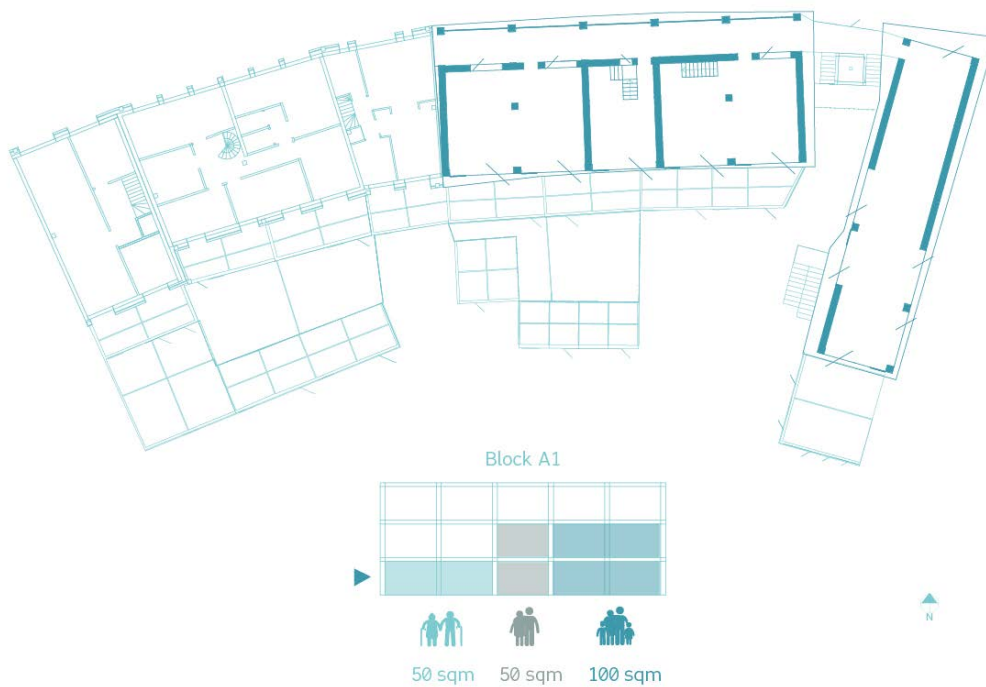

Figure 7.32 Second floor plan: rooftop additions blocks A1 and B (source: author)

Concerning the second floor plan, the first level apartments of blocks A1 and B can be shown. The additions on block A are provided with an open air gallery which is needed to permit the access to each apartment. The steel and glass stairs and elevator's structure to give access to the additions on blocks A and B have been positioned between the two blocks in order to highlight and fill the existing gap, and a separate access is provided to connect with the inner back part of the buildings. Moreover, block B's addition is composed by one apartment of about 80 sqm for each of the three new floors.



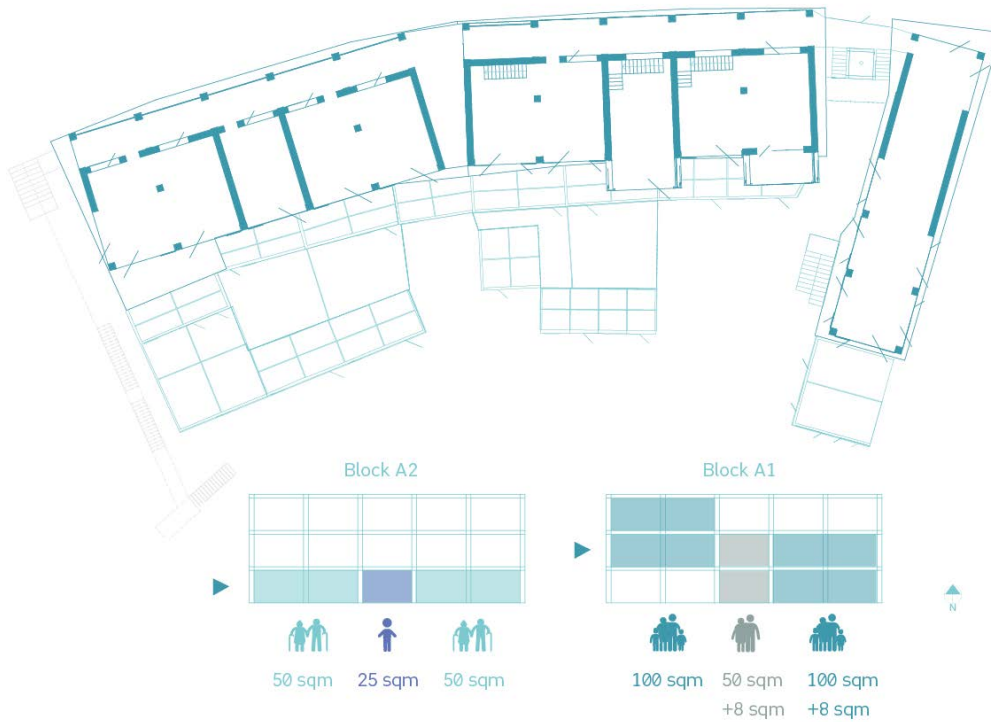

Figure 7.33 Third floor plan: rooftop additions blocks A1, A2 and B (source: author)

Regarding the third floor plan, it includes the A2 addition on the west part of block A and it is connected to A1 by a glass passage in the middle of the block. It can also be seen that two apartments in block A1 have been provided with respectively a winter garden and a balcony, as they are additional components that can be asked by the tenants and are used to increase the internal useful surface of the dwellings with about 8 sqm. Moreover, other stairs have been located in the west side in order to respect the fire emergency regulation.

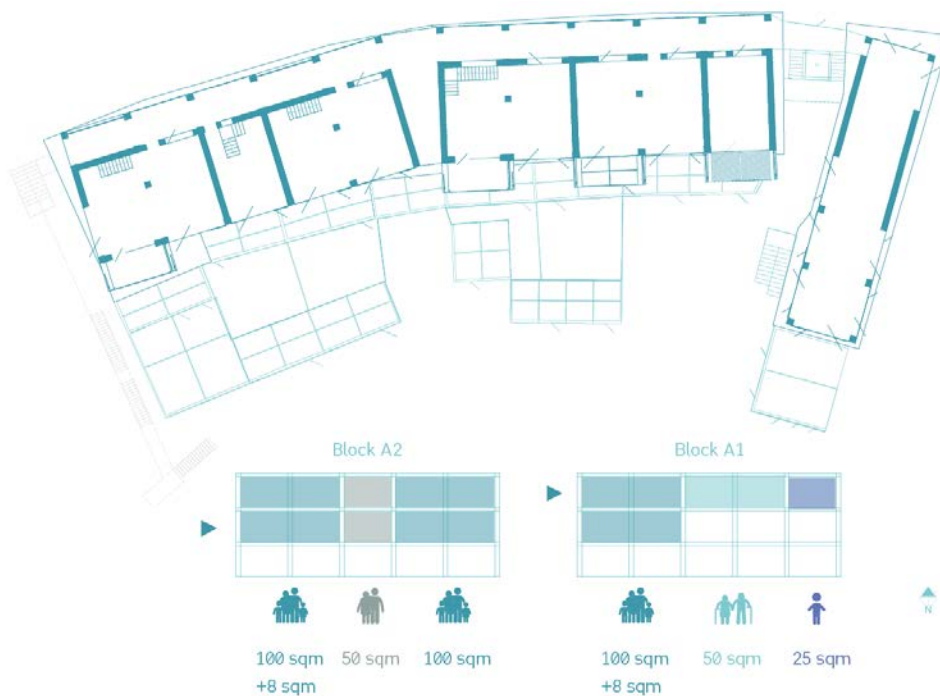

Figure 7.34 Fourth floor plan: rooftop additions blocks A1, A2 and B (source: author)

The fourth floor plan shows that the balconies are provided with a brise soleil roof grid combined with glass in the inner part, while the winter gardens have a photovoltaic glass roof as the adhesions to the existing.

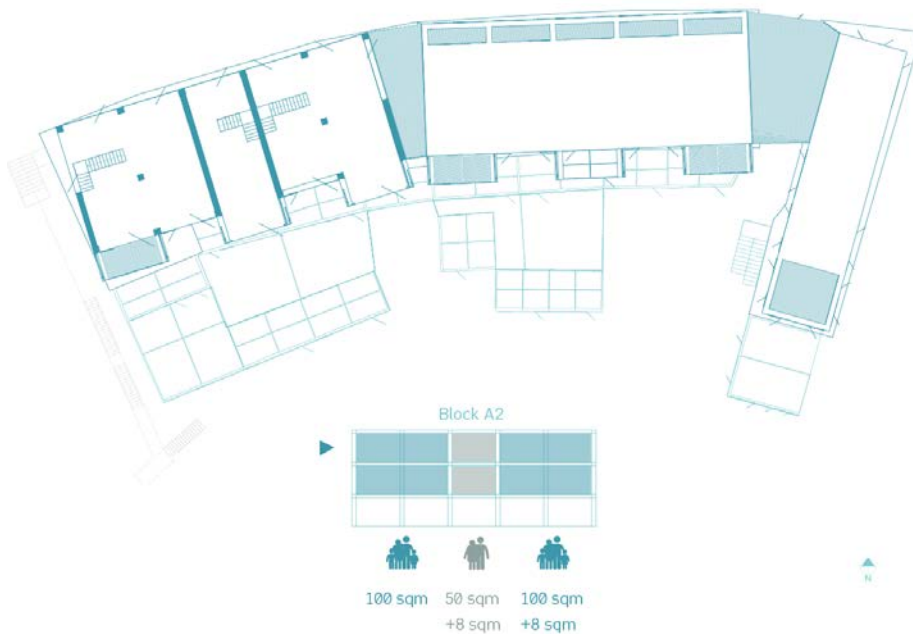

Figure 7.35 Fifth floor plan: rooftop additions block A2 (source: author)

The fifth floor plan shows block A1 and Bs' roofs, provided with brise soleil spots combined with glass in the inner part, also the main entrance with the stairs and the elevator between A1 and A2 are covered with the same components. Moreover, thanks to this chosen family units combination, the last floor of block A2 is composed by the first floors of the lower apartments so that the external gallery is no more required and the dwellings can achieve more useful surface by expanding towards north. The north façade of this addition is entirely composed by glazing walls so that the sea-view is provided.

The floor plans are presented as open spaces without internal partitions as the areas are thought as flexible so that each dwelling's internal surface can be designed following the tenants' needs. Although, possible internal partitions are presented for each family unit apartment to show how the adaptability of the dwellings.

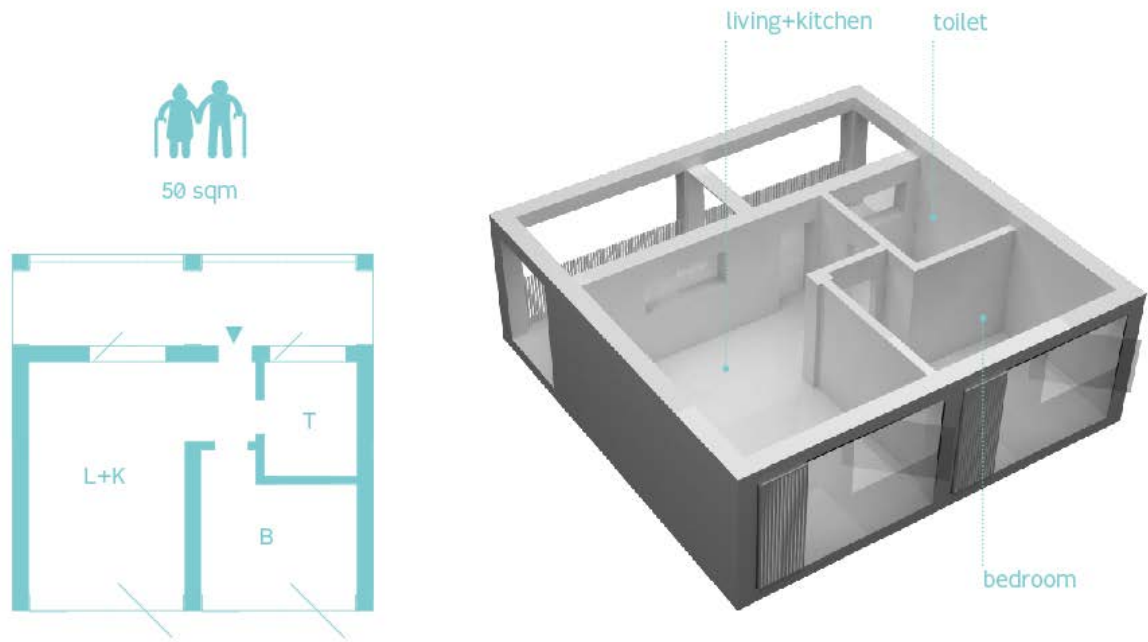

Figure 7.36 Internal partition of the apartment: elderly couple (source: author)

The elderly couple is provided with a two-room apartment of about 50 sqm on one floor so that is more adaptable for the needs of motion of the aged. It is composed by an open space for the living room and kitchen, a bedroom and a toilet. Cross inner ventilation is guaranteed thanks to the presence of windows facing the gallery and glass facades facing the south, equipped with movable brise soleil and openings. The south façade can be provided with balconies or winter gardens depending on the tenants' requests.

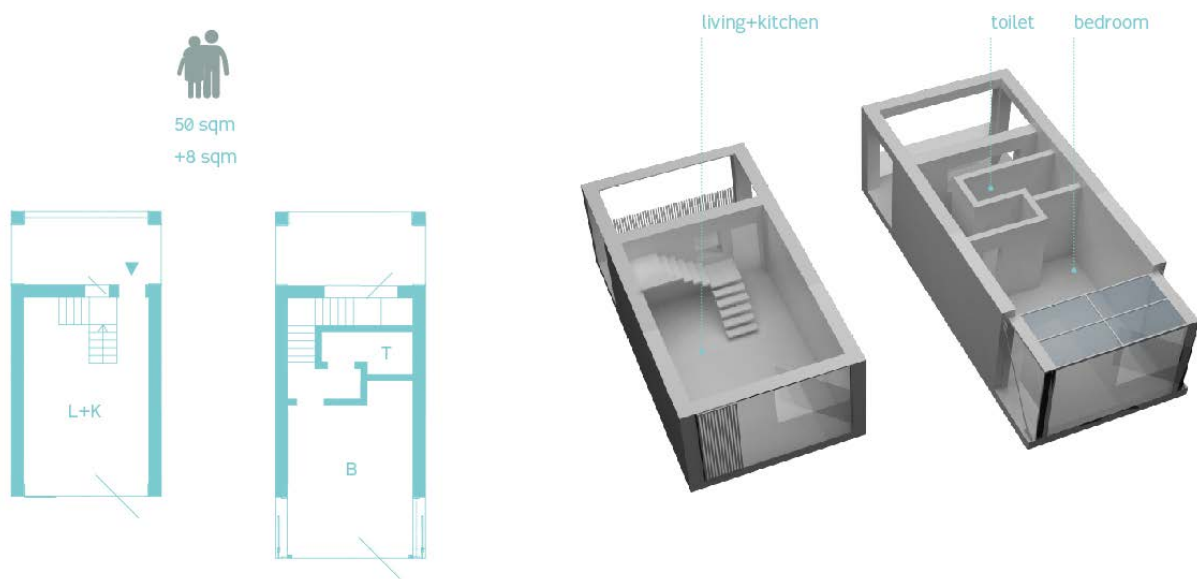

Figure 7.37 Internal partition of the apartment: young couple (source: author)

The young couple is provided with a two-room apartment on two floors of about 50 sqm in total. The first level has an open space for the living room and kitchen, while the second is

composed by a bedroom and a separate bathroom. Cross inner ventilation is guaranteed by the presence of openings facing the gallery and glass facades towards the south, provided with movable brise soleil. The south façade can be provided with balconies or winter gardens depending on the tenants' requests.

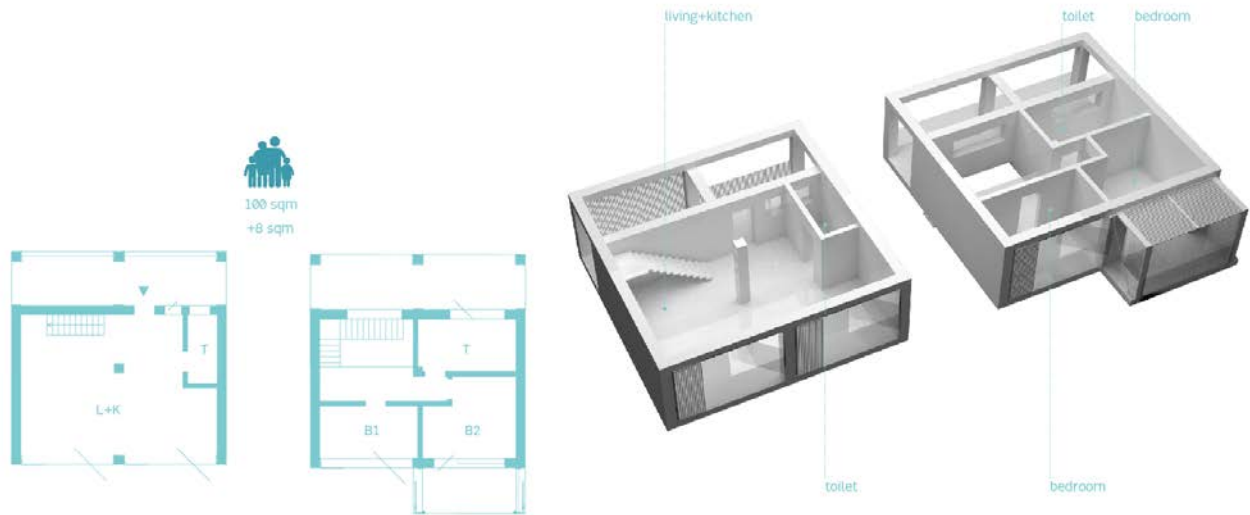

Figure 7.38 Internal partition of the apartment: family (source: author)

The family is provided with a three-room apartment on two floors of about 100 sqm in total. The first level is composed by an open space for the living room and kitchen and a toilet, while the second level is organised with two bedrooms and a toilet. Cross inner ventilation is guaranteed by the presence of openings facing the gallery and glass facades towards the south, provided with movable brise soleil. The south façade can be provided with balconies or winter gardens depending on the tenants' requests.

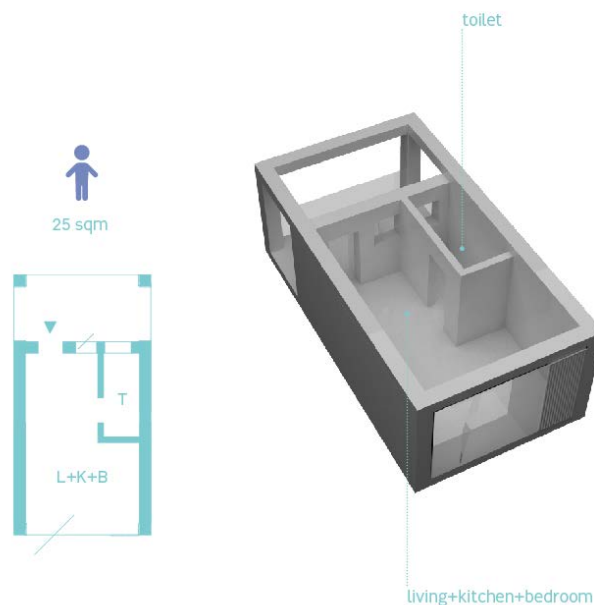

Figure 7.39 Internal partition of the apartment: studio (source: author)

The type of dwelling is thought as a studio apartment for students of about 25 sqm, cross inner ventilation is guaranteed by the presence of openings facing both north and south and the internal useful surface can be increased by adding to the south façade a balcony or a winter garden.

The architectural components that lead to a personalization of the dwellings depending on the tenants' needs, are the winter gardens and balconies modules that can be added to the south façade of the rooftop additions in order to gain sun light and increase the internal useful surface of the apartments.

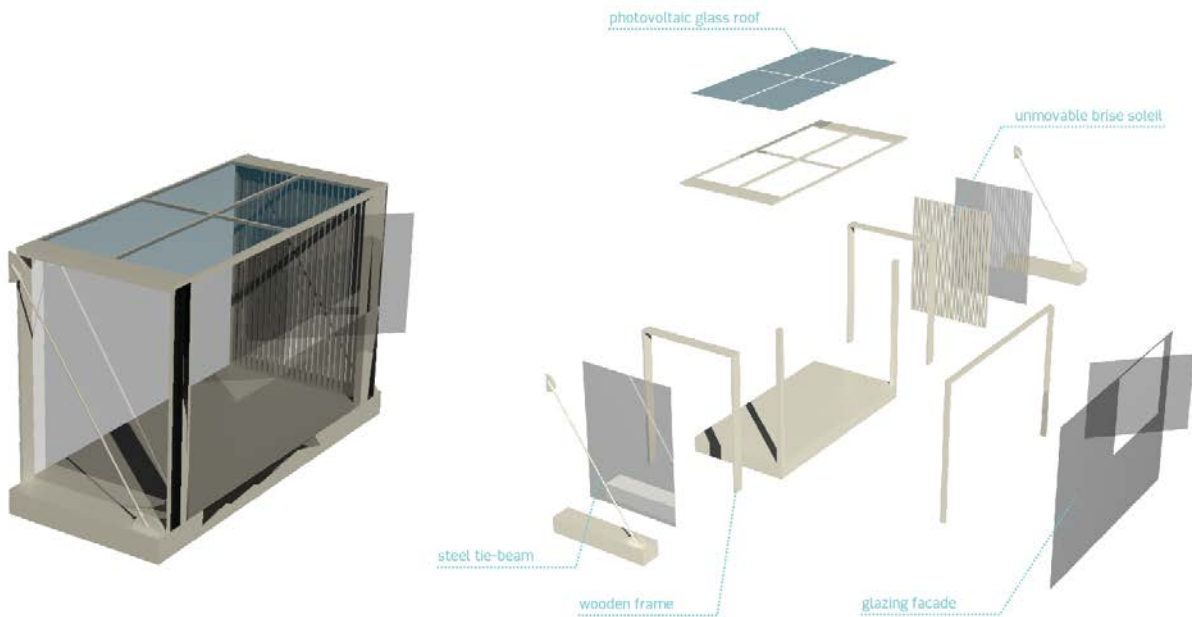

Figure 7.40 Architectural component: winter garden (source: author)

The winter garden module is a 8 sqm addition to the façade, made of a wooden structure of columns and frames and steel tie-beams to sustain the ledge. It is surrounded by glass, with a photovoltaic glass roof and an unmovable brise soleil positioned towards east, in order to gain privacy from the neighbourhood.

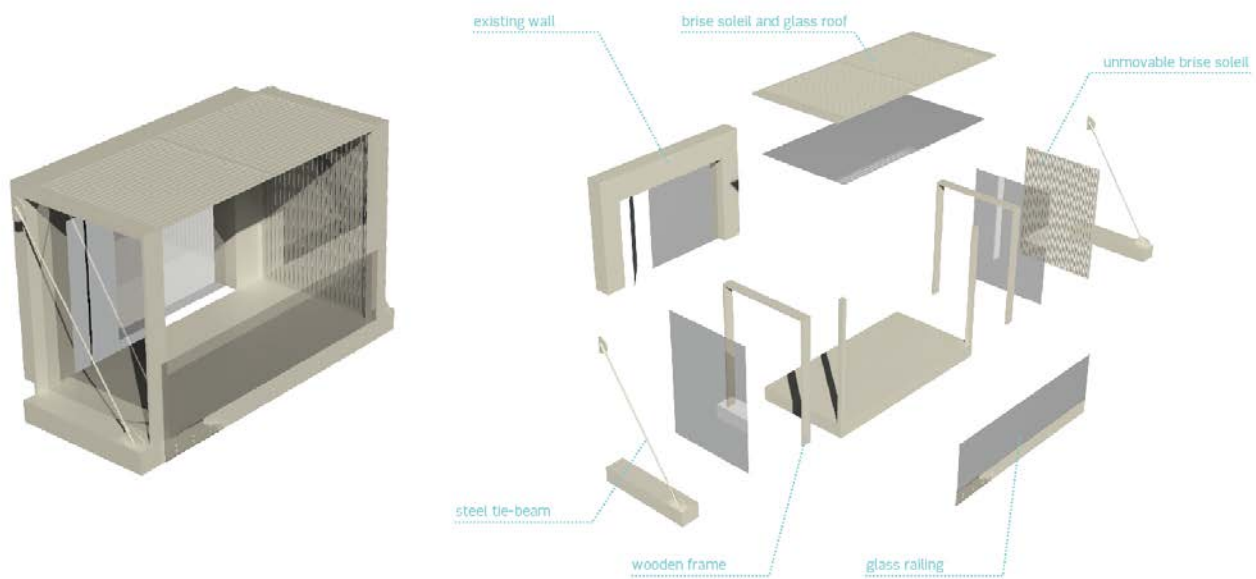

Figure 7.41 Architectural component: balcony (source: author)

The balcony module is an 8 sqm addition to the façade, made of a wooden structure of columns and frames and steel tie-beams to sustain the ledge. It has a glass railing and the eastern glass wall is covered by a grid of brise soleil in order to gain privacy from the neighbourhood. The roof is made of a grid of brise soleil and an internal layer of glass.

The need of personalization of the dwellings by adding architectural components to the facades is an approach that can add value to the typical modular and prefabricated constructions. An example of customization of the dwellings is the IJburg Island, a residential neighbourhood near Amsterdam, built in 1997 (now extending) on an artificial island on IJmeer Lake, where blocks of neighbouring houses have been built, each one characterized by architecturally relevant facades and compositions. The street view provides colourful and different individual four-story housing as the economically advantaged population could create here their house as they wished.



Figure 7.42 IJburg houses (source: google images)

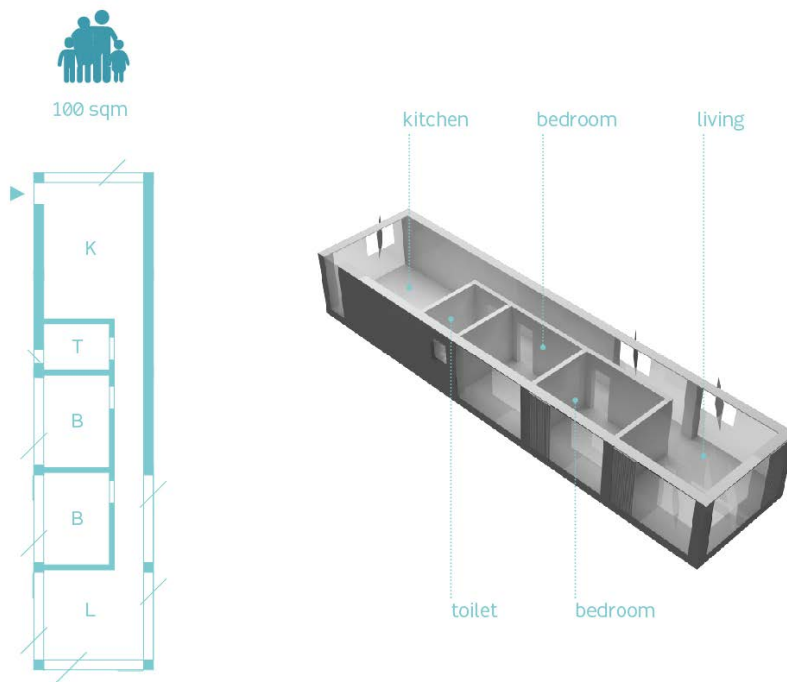

Figure 7.43 Internal partition of the apartment: rooftop addition on block B (source: author)

The rooftop addition on block B cannot be composed by the family units apartments used for the ones on block A because of its long shape. For this reason, each floor is occupied by an apartment of about 100 sqm, each one with two rooms, with the living room facing the south and the kitchen towards north.

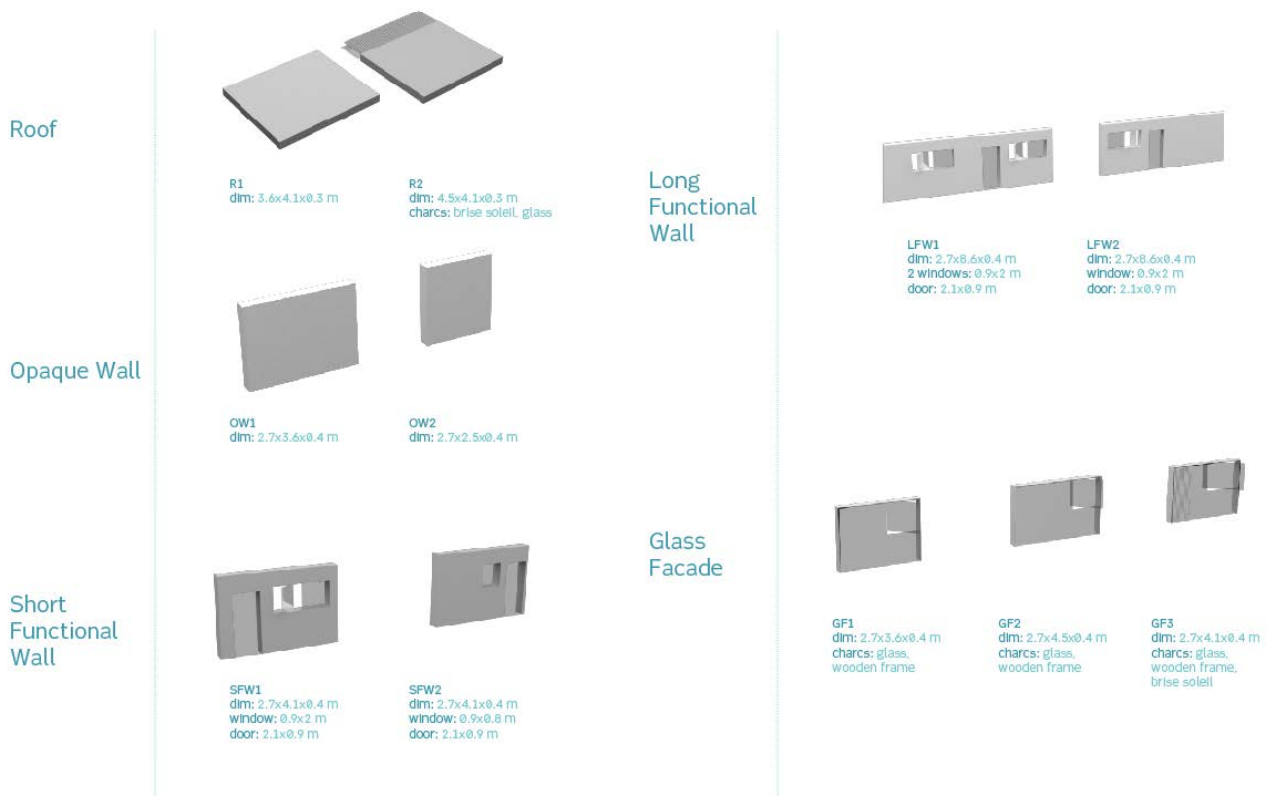
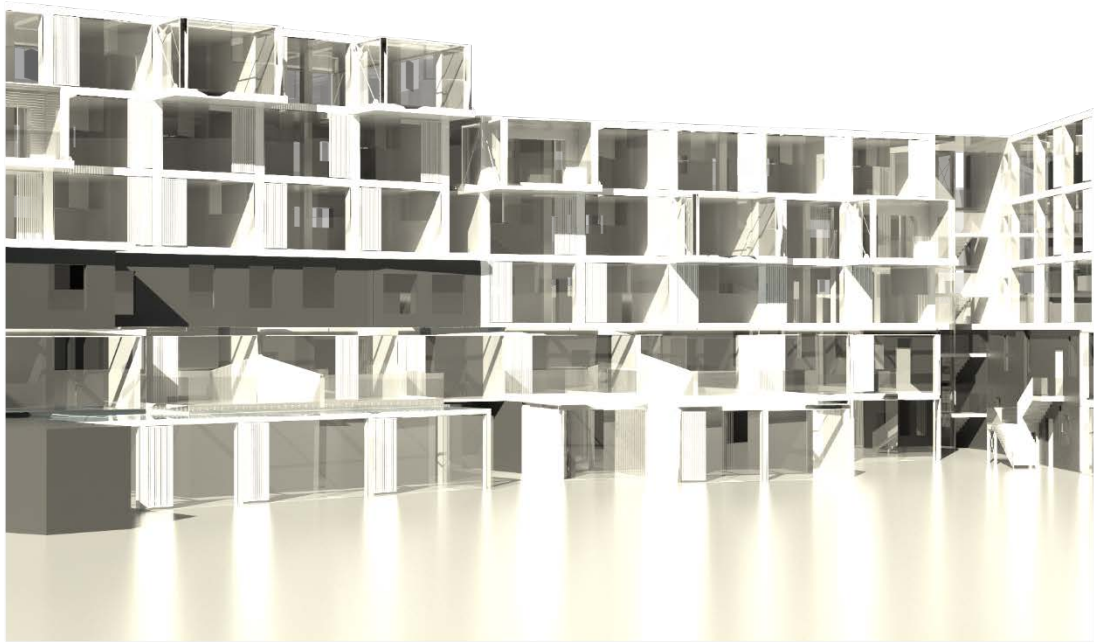

Figure 7.44 Abacus of the main architectural components: roof, walls and facade (source: author)

The prefabrication process is characterised by a series of elements that arrive to the building site ready to be positioned in their location. The simple and modular structure of the additions facilitates the prefabrication approach to be carried on. An abacus of the main standardised architectural components for block A's rooftop addition can be elaborated, underlining their main characteristics and dimensions and identifying them with code names that enable their location inside the project.

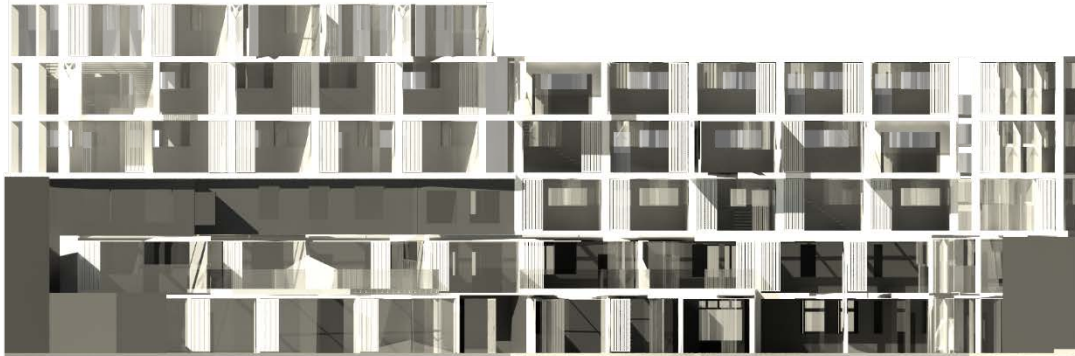





*Figure 7.45 Rooftop additions: perspective north and south views renders (source: author)*





*Figure 7.46 Rooftop additions: north and south facades renders (source: author)*

The south façade is mainly characterised by openings and glass facades in order to gain sun lights due to its orientation. Winter gardens and balconies can be added to the dwellings in order to increase their internal useful surfaces and characterise the façade.

The existing gap between block A and block B has been filled with the stairs and elevator that give access to the rooftop additions. The structure of the elevator is made of steel pillars, beams, bracings and glass, while the stair's steps are made of steel perforated plates connected to steel beams directly sustained by the elevator's steel structure. The passages connecting block A with block B are sustained by the elevator's structure and the rooftop additions' structure. The north façade of the additions is characterised by the galleries leading to the dwellings and the first level railings are made of wooden listels, while the other two upper floors are marked with steel and glass railings. However, where opaque surfaces are located, listels are used to cover the entire opening between the structure's wooden pillars in order to characterise the façade. The connection between A1 and A2 rooftop additions is a glass passage having view on both south and north, with a roof made of wooden listels and glass.

## 7.8.4 Assistant building

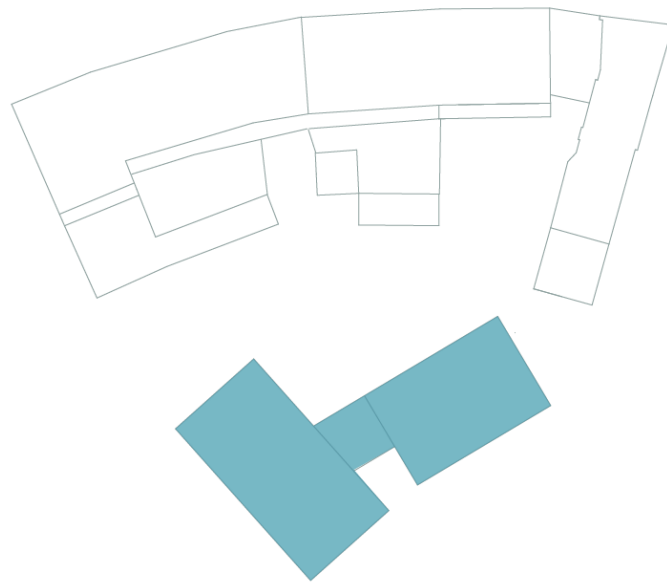

Figure 7.47 Scheme of the new volumes: assistant building (source: author)

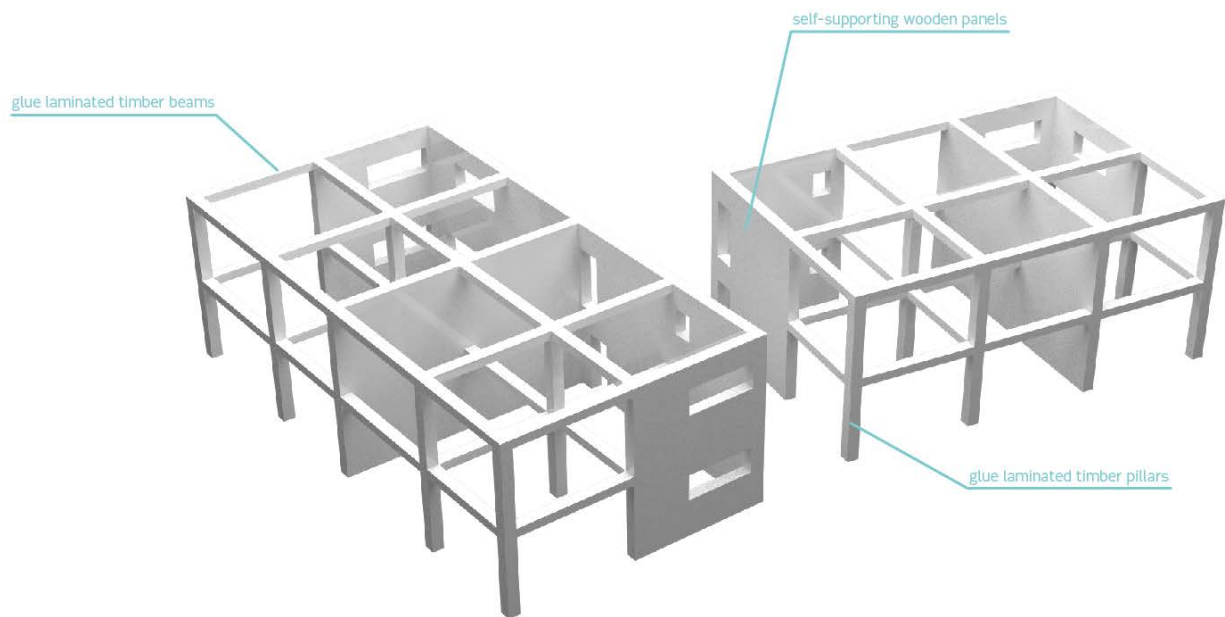

Figure 7.48 Assistant building's structure (source: author)

The assistant buildings are two floors constructions composed by 30x30 cm glue laminated timber columns and 30x40 cm beams and cross laminated timber panels. The buildings are connected by a steel and glass structure that hosts the elevator and the stairs to reach the apartments and the roof gardens.

The total internal useful surface is about 675 sqm, and it can be divided into different apartments, depending on the family units that are required, as for the rooftop additions on block A.



Figure 7.49 Assistant buildings' ground and first floor plans (source: author)

An example of combination of family units is presented: four elderly couple apartments, one family apartment and one single couple apartment. The living rooms are all facing south or south-west in order to gain solar lighting during the day. The main entrance gives access to the elderly couple apartments and to the top roof gardens, through the stairs and the elevator.

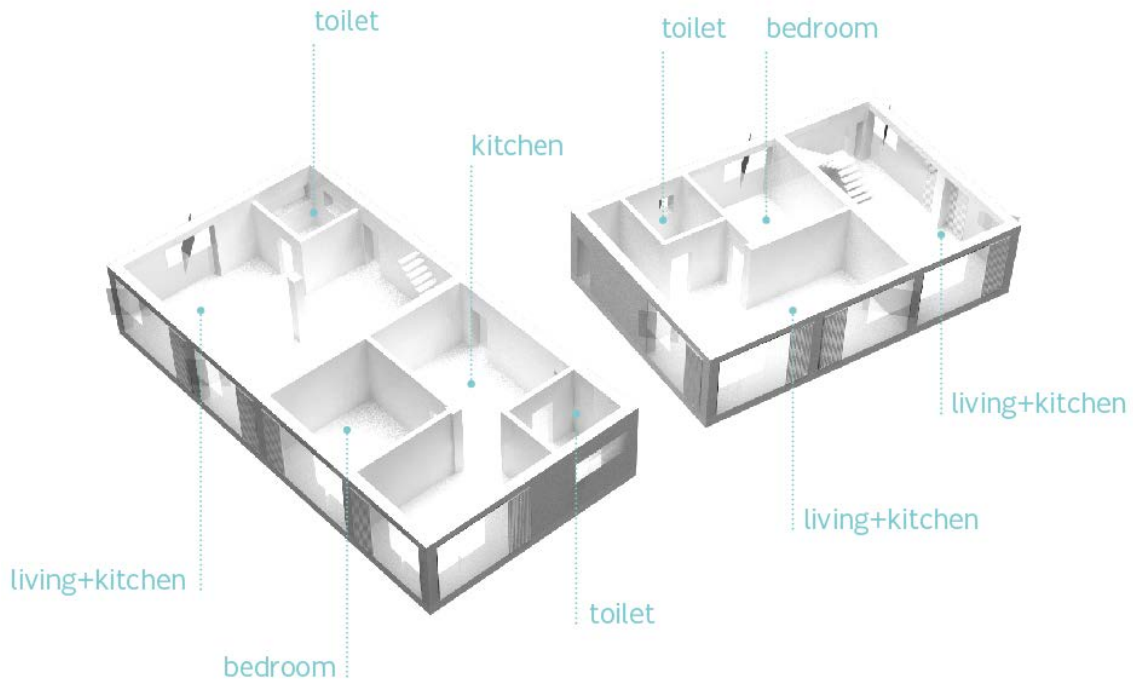

Figure 7.50 Assistant buildings' internal partition: ground floor (source: author)

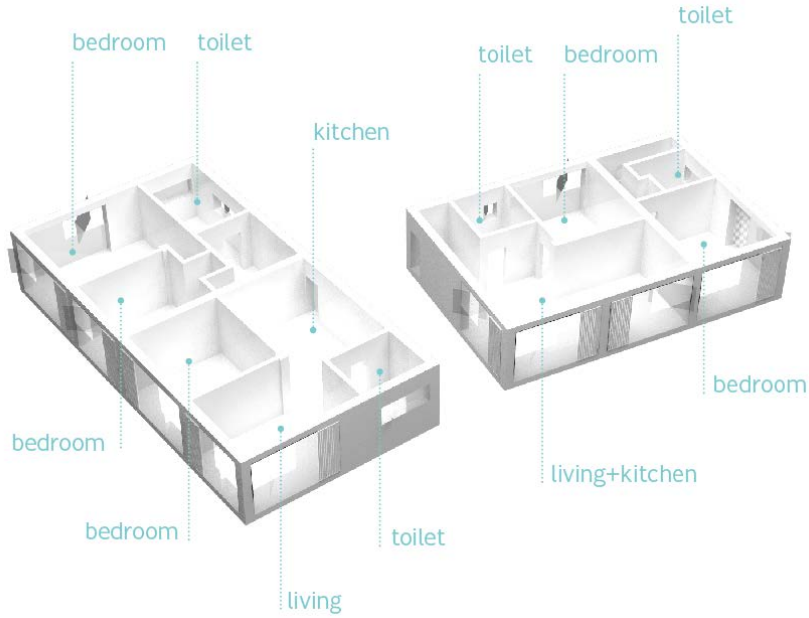
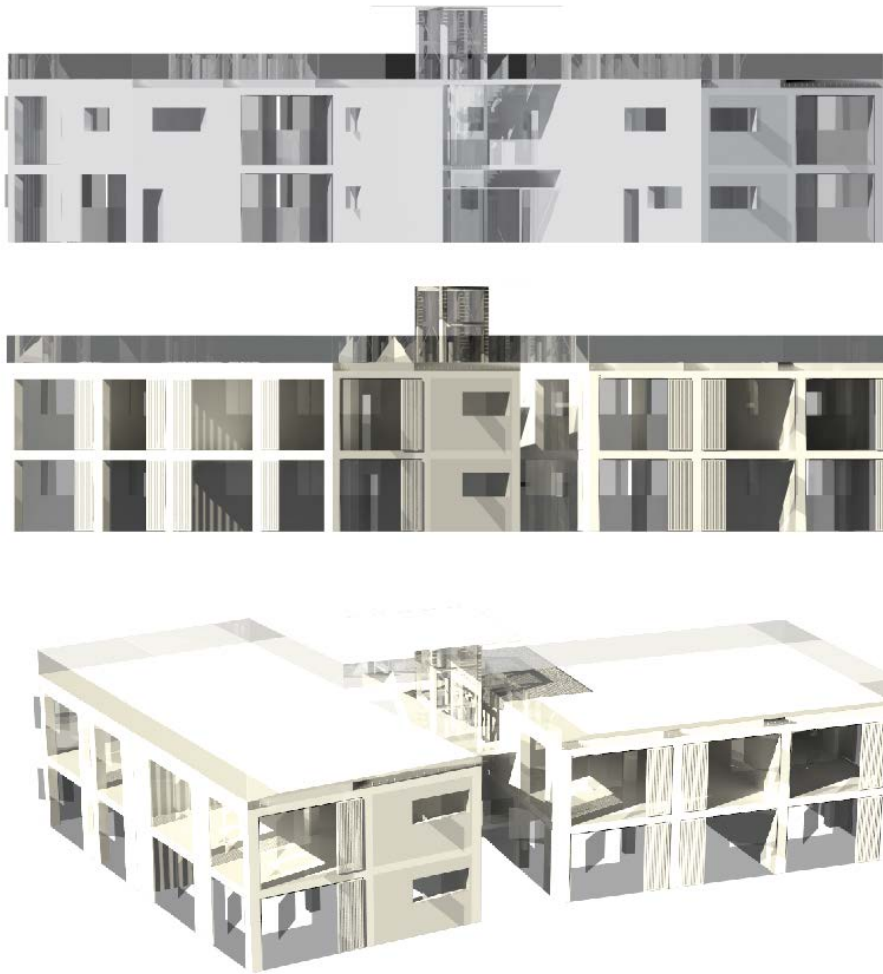

Figure 7.51 Assistant buildings' internal partition: first floor (source: author)



*Figure 7.52 Assistant buildings: north and south facade renders and perspective render south view (source: author)*

Brise soleil are used in the south and west façades in order to give shading and the steel and glass stairs and elevator are covered by a brise soleil grid.

## 7.9 Technical details

A technical detail has been studied for what concerns the connection between the steel box shape pillar sustaining the rooftop additions and the existing brick walls.



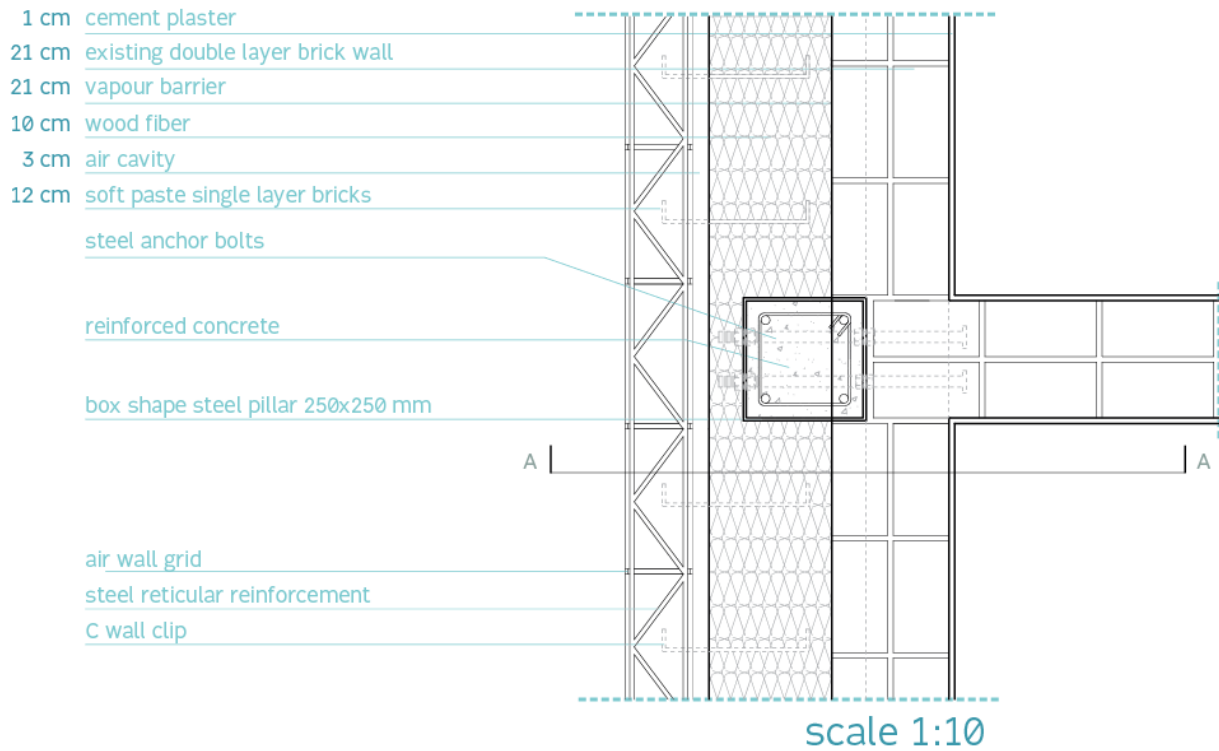
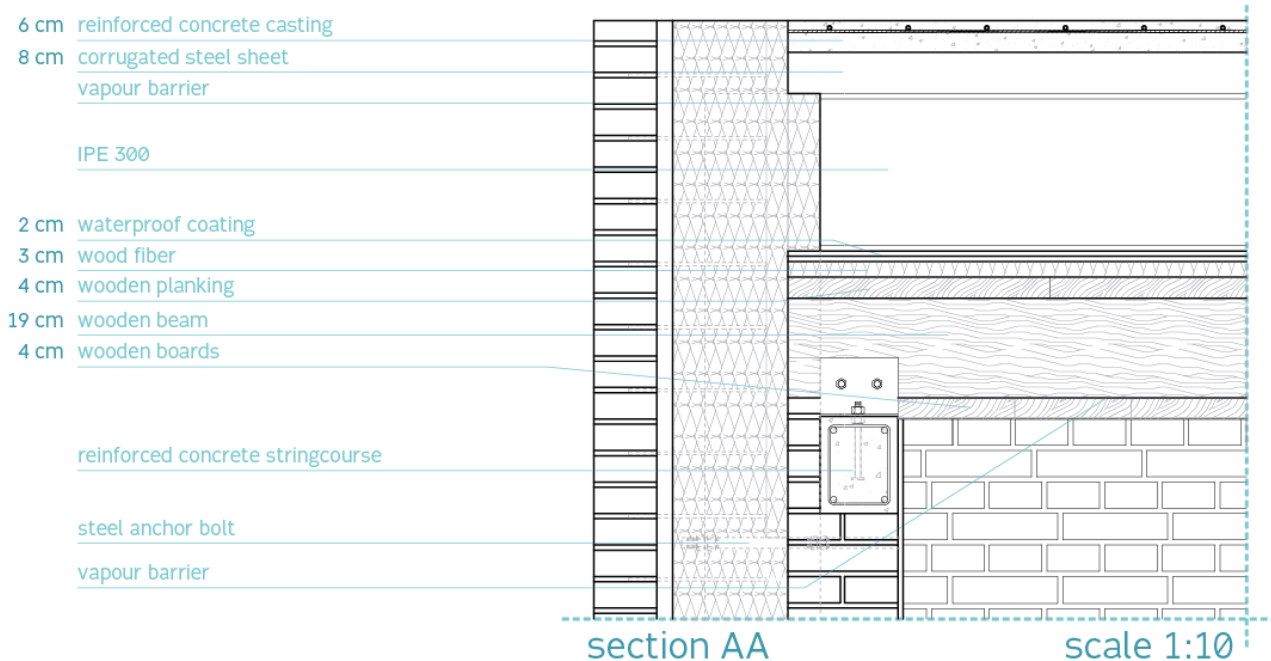

Figure 7.53 Technical detail: connection between pillar and existing brick wall (source: author)

The steel box shape pillars 220x220 mm sustaining the rooftop additions are connected to the existing cross brick wall through steel anchor bolts positioned along the pillars' height with the use of mortar. The pillars are filled with reinforced concrete, while the new bricks layer is reinforced with a steel reticular. Moreover, C steel wall clips are used to connect the soft paste bricks with the insulation layer of wood fiber and air wall grids are used to enable the convectional motion of the air inside the cavity and avoid condensation events.



*Figure 7.54 Technical detail: existing building's new roof (source: author)*

At the top of the existing brick wall a reinforced concrete stringcourse has been inserted in order to strengthen the global behaviour of the masonry. The wooden beams of the roof have been joint to the stringcourse by applying an L steel bracket and bolting a steel anchor bolt inside the concrete. The wood fiber has been turned up in order to obtain a continuous insulation layer that avoids thermal bridges. The steel box shape pillars are welded to the steel IPE 300 beams that constitute the steel table sustaining the rooftop additions with the help of IPE 160 steel beams.

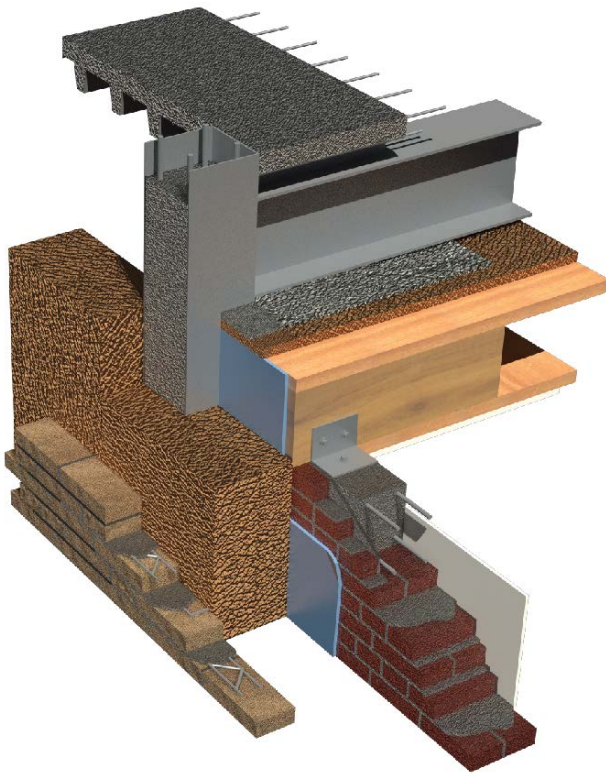

*Figure 7.55 Technical detail: 3D connection between pillar and existing brick wall and existing building's new roof (source: author)*

## 7.10 Energy demand of the project

Concerning the existing buildings, the energy demand has to be calculated including the winter gardens added and considering the energy efficiency measures applied, as well as the increase in thickness of the wood fiber in the thermal coat from 10 to 22 cm in order to hide the steel pillars of the structure sustaining the rooftop additions. For what concerns the new volumes, the PEI has been calculated for the assistant buildings, considering that the architectural components used are the same also for the rooftop additions.

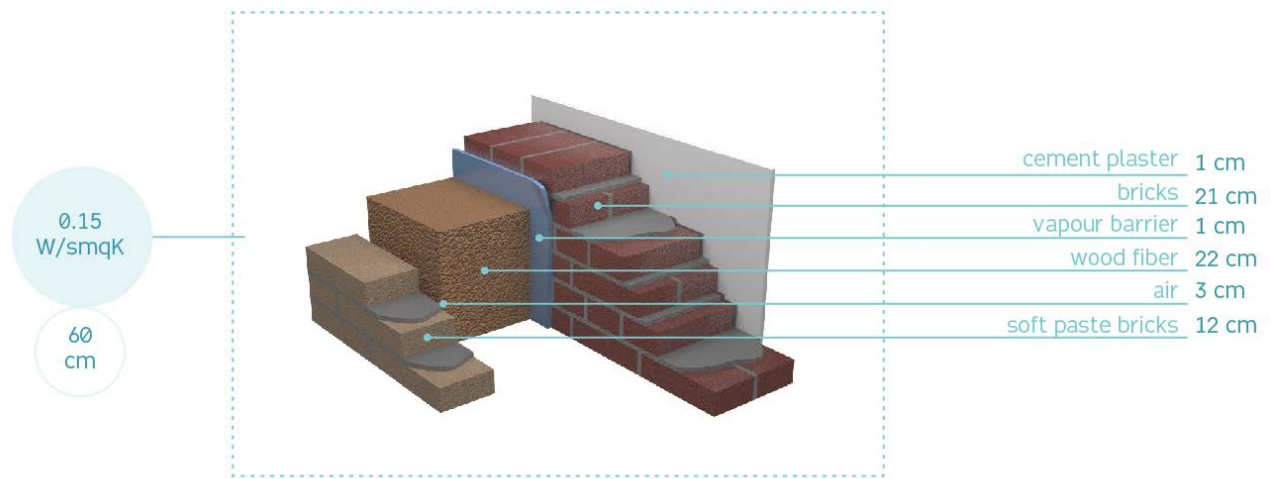

Figure 7.56 3D detail of the existing buildings' new wall: thermal transmittance and layers' thicknesses (source: author)

The thermal transmittance of the refurbished existing walls is about  $0.15 \text{ W/sqmK}$  and the total wall's thickness is  $60 \text{ cm}$ .

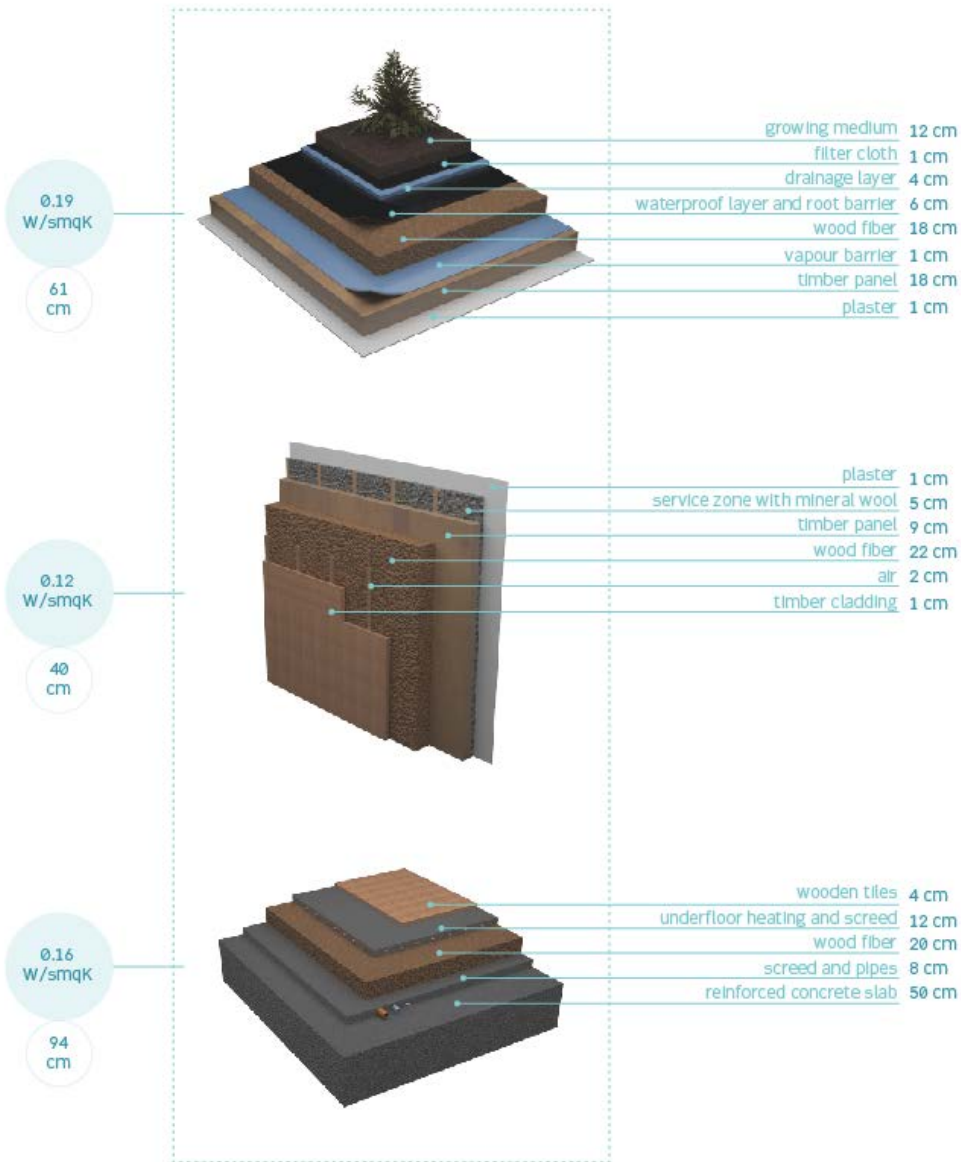

Figure 7.57 3D details of the architectural components of the assistant buildings, with thermal transmittances and layers' thicknesses: roof, wall and ground floor (source: author)

By considering the assistant buildings, the thermal transmittances are 0.19, 0.12 and 0.16 W/sqmK respectively for the roof, walls and ground floor.

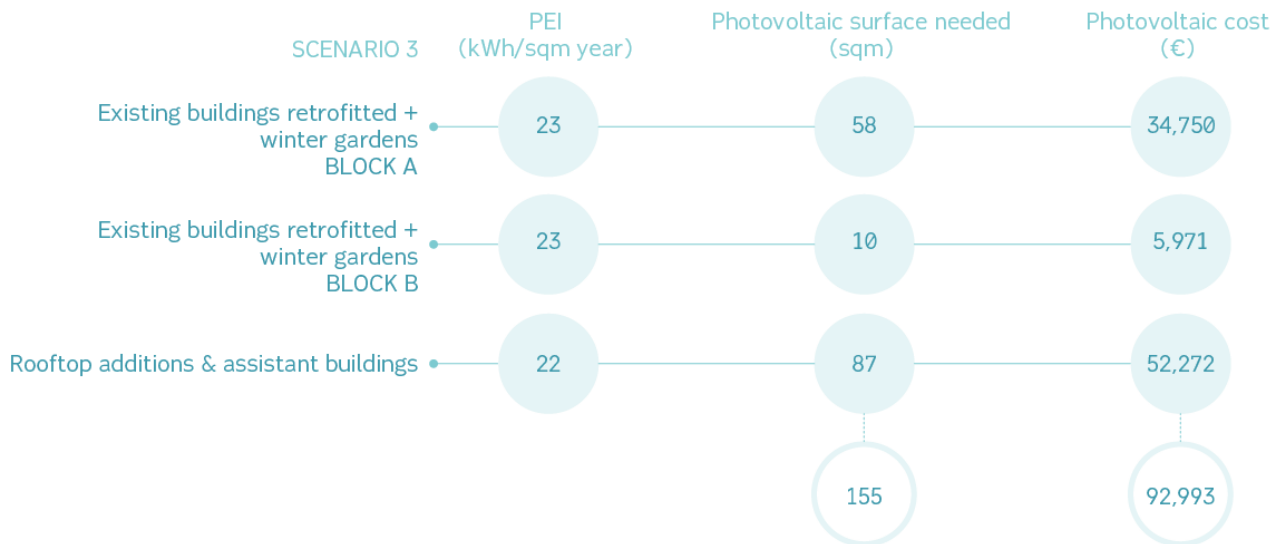

Table 7.7 PEI, photovoltaic square meters needed and photovoltaic cost: existing refurbished buildings + winter gardens, rooftop additions & assistant buildings (source: author)

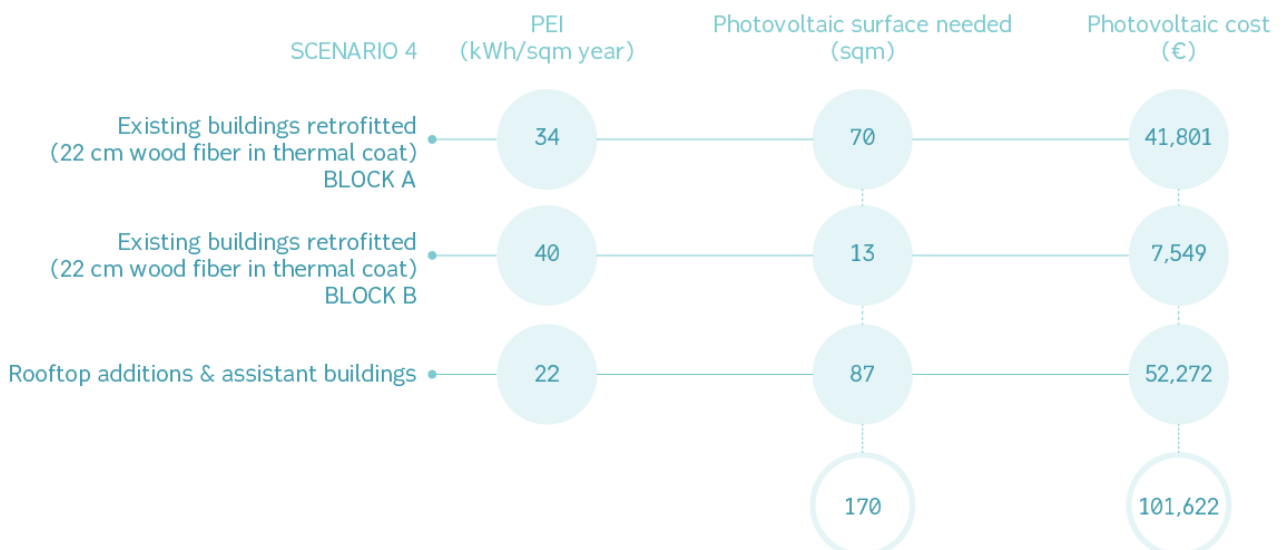
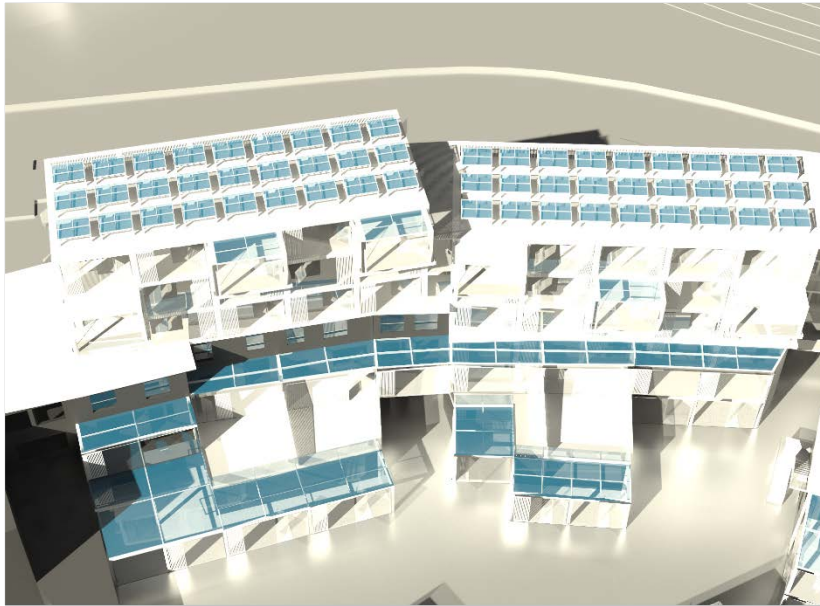

Table 7.8 PEI, photovoltaic square meters needed and photovoltaic cost: existing refurbished buildings, rooftop additions & assistant buildings (source: author)

By considering scenario 3, the PEI for the existing buildings with the winter gardens added is 23 kWh/sqm year for both block A and B, while it is about 22 kWh/sqm year for the new buildings. The total photovoltaic surface needed to cover the remaining energy need is about 155 sqm with a total cost of about 92,993 euros. The photovoltaic panels can be located on the rooftop additions' roofs.

Even if scenario 4 had a lower payback time, the adhesion of the winter gardens in scenario 3 gives a lower energy demand of the refurbished buildings, with a consequent lower need of photovoltaic panels. In fact, the refurbished blocks without winter gardens added have respectively PEI of 34 and 40 kWh/sqm year, with 170 sqm of photovoltaic panels needed and 101,622 euros as total cost.



*Figure 7.58 Photovoltaic panels on rooftop additions (source: author)*

## C. Conclusions

# 8 Conclusions and recommendations

## 8.1 Conclusions

### 8.1.1 Process summary

Regarding the main issue of the thesis, the add-ons strategy was evaluated as a possible mean to create a new market for energy renovation of existing buildings. Hence, the central part of this study is to identify the necessary conditions that could make possible this type of intervention for an existing case study, concerning the normative, architectural, economic and technologic issues. For these purposes, a mixed research was carried out, including a literature review, the analysis of existing case studies and the design of add-ons on a Dutch case study.

Step	Objective
Literature research	• Energy efficiency measures in the existing housing stock in Europe and Netherlands
Study of existing case studies	• Best practices and different approaches
Scheveningen Case Study:	
• SWOT Analysis	• Environmental and architectural criticalities
• Energy demand calculation	• Actual cost of energy need
• Energy efficiency measures	• New energy label reached
• Definition of sustainability and economic parameters	• Statement of the main issues to evaluate during the design process
• Economic scenarios	• Economic feasibility of the interventions
• Design phase	• Add-ons proposal, architectural and technical details
• Energy demand of the project	• Check of the energy renovation and design's effectiveness

Table 8.1 Process summary and objectives (source: author)

Each step of the thesis has reached the objectives required to draw the entire process so that the research question can be answered at the end of the study.

### 8.1.2 Examples conclusions

The analysis of the case studies, seen as best practices, was useful in order to investigate the effective feasibility of the add-ons strategy and get an overview on different approaches.

Building name	Main characteristics
• The Himmerland Housing Association, Departments 19 & 22	• Renovation of the existing, rooftop addition, prefabrication, new housing types introduced
• The 'Bois Le Pretre' Tower	• Winter gardens and balconies, prefabrication
• The Giesshübel pile up	• Renovation of the existing, rooftop addition, prefabrication, timber
• Tower and line social housing blocks in Bologna	• Renovation of the existing, adhesion, rooftop addition, assistant buildings, prefabrication, different housing typologies

Table 8.2 Main characteristics of the add-ons examples (source: author)

The best practices research has been useful in order to highlight the main characteristics of each approach and define the guidelines for the case study design. In fact, it can be verified that all the examples' aspects have been included in the thesis project.

### 8.1.3 Dutch case study conclusions

The central part of this thesis, consists of the investigation of a new case study, an existing block of buildings in The Hague, in the Scheveningen district. Initially, a detailed analysis of the actual state was carried out, by stating the SWOT analysis for the construction. Then, the calculation of the energy demand was carried out in order to state the consequent energy efficiency measures to be applied on the existing buildings. Moreover, different scenarios based on the cost-benefit analysis were elaborated in order to check the boundaries of the intervention's feasibility. Finally, the design process was carried out with details about the technical realization of the new construction. Concluding, this research indicates the conditions that could lead to a feasible add-ons intervention on an existing building in need of energy renovation. As an outcome of the Scheveningen case study, it is suggested to introduce the add-ons strategy as a normal practice in buildings' energy refurbishment, when there is physical space for it, regarding the benefits and perspectives that have been revealed for both owners and tenants on the basis of energy efficiency and economic profit.



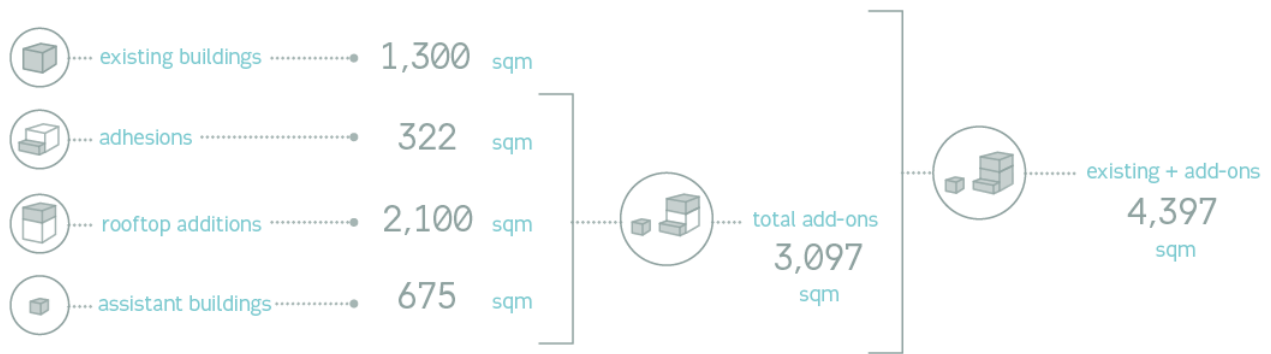
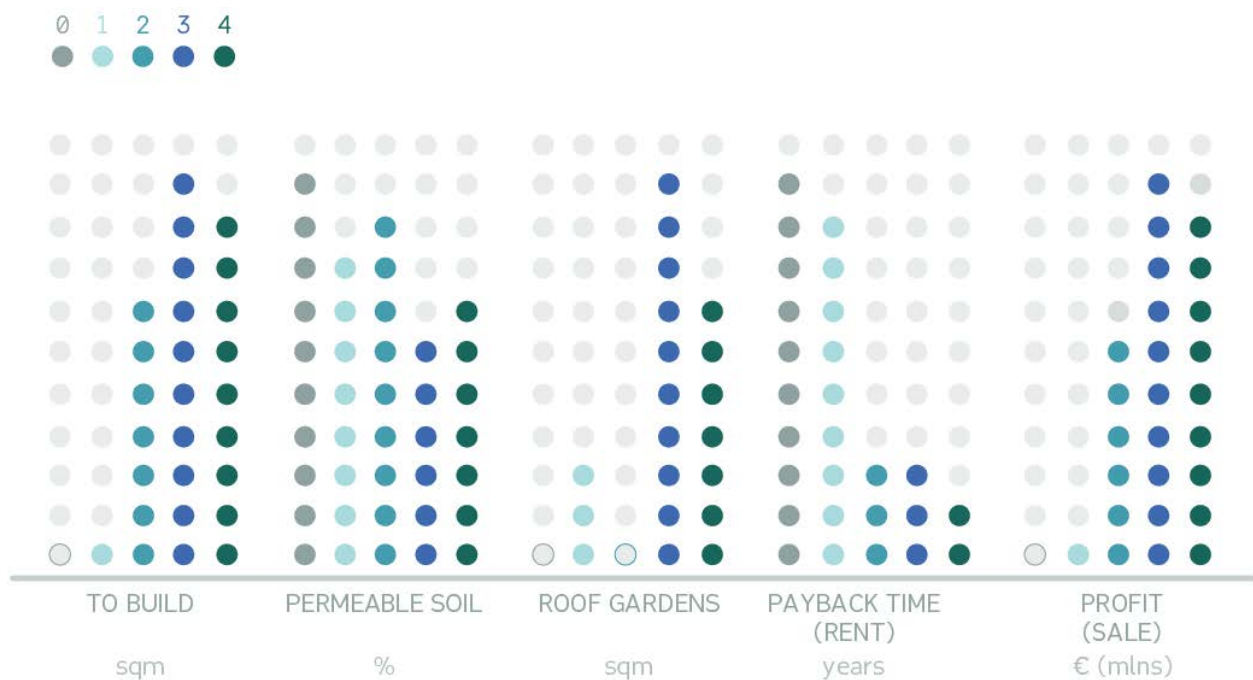

Table 8.3 Final surfaces: Dutch case study (source: author)

It can be stated that the total amount of add-ons considered is 3,097 sqm that added to the existing 1,300 sqm give 4,397 sqm.



Graph 6.1 Summary graph about scenarios' data (source: author)

By considering the parameters fixed at the beginning of the design process, a comparison between the scenarios can be done. First of all, scenario 3 considers the maximum amount of sqm to build, about 3,097 sqm. The maximum gain of permeable soil is achieved by scenario 2 that consists of the only rooftop additions. Moreover, the maximum surface of roof gardens is obtained by scenario 3, covering both existing and assistant buildings' roofs. As for the payback time, scenario 4 gives the shortest, while for the profit through the sale, scenario 3 gives the highest.

As conclusion of the research, it is necessary to answer to the research question fixed at the beginning of the thesis:

Which are the necessary conditions that could lead to the feasibility of the add-ons strategy on the case study, in normative, architectural, economic and technologic terms?

## Normative and architectural perspective

First of all, when approaching to a high energy consuming building, in order to apply the add-ons strategy, the regulations concerning the permitted interventions in the area must be considered. By doing this, it can be stated which are the physical limits to the project. Scheveningen case study had space for several types of additions, following the ABRACADABRA Project standards: adhesions to the existing, rooftop additions and assistant buildings. The adhesions could only be made in the south part of the block, as for the assistant buildings' location. The adhesions could only be made in the south part of the block, as for the assistant buildings' location. The municipality permitted maximum heights of respectively 18 and 9 meters for the construction of the rooftop additions and assistant buildings. In addition, regulation concerning the parking and the fire protection had to be respected. A second stair was thought to connect the rooftop additions in order to follow the fire emergency rules, while for the parking, planning fees for the municipality were considered in the construction cost, in order to avoid the construction of parking inside the block and leave out of the property vehicles and pollution. Finally, the design of the add-ons had to fit coherently in the existing environment, without damaging it, but, on the contrary, giving it surplus value. The main concern was to avoid the alteration of the existing in terms of deprivation of the actual conditions, but on the contrary to add benefits. The winter gardens were used to extend the existing dwellings, facilitate the cross inner ventilation and decrease the energy demand through an architectural adaptation, showing that the design can sensibly contribute to the consumption of buildings. Moreover, the design of the assistant buildings had firstly to respect the existing construction and, in particular, avoid shading on it, also because otherwise the winter gardens would not have effectiveness.

## Economic perspective

The Scheveningen case study required the consideration of both rent and sale approaches. As for the rent, a payback time of less than 15 years must be reached in order to be feasible, while for the sale, the feasibility of the investment depends on the consistency of the profit.

		PAYBACK TIME (RENT) years	PROFIT (SALE) € (mlns)
 scenario 0		38	-0.2
 scenario 1		35	0.3
 scenario 2		12	3
 scenario 3		11.9	4.7
 scenario 4		<b>11.3</b>	4.1

Table 8.4 Summary table about scenarios' data (source: author)

The five economic and volumetric scenarios have been compared on the basis of the data concerning the interventions and it can be stated that the lowest payback time through the rents is obtained by the combination of the rooftop additions and the assistant buildings (scenario 4), while the highest profit through the sale is obtained by the combination of the rooftop additions with the assistant buildings and the adhesions (scenario 3). Scenario 2, regarding the only rooftop additions, seemed also feasible, as the payback time is lower than 15 years and there is also a consistent profit through the sale.

Concerning the rent approach, the construction of the only winter gardens is not enough in order to obtain a feasible payback time, lower than 15 years, whereas the sale gives a small profit. Comparing scenarios 3 (adhesions, rooftop additions and assistant buildings) and 4 (rooftop addition and assistant buildings), it is clear that the payback time is decreased more consistently by not including the winter gardens rather than considering them, meaning that the payback time equation through the rent has not a linear correlation between sqm to build and payback time. In particular, the money per year gained through the adhesions to the existing is less than the money gained through the rent of new dwellings. Also, in scenario 3, the numerator increases, in comparison to scenario 4, as it includes the construction cost of the winter gardens. As a conclusion, the relationship between costs and new rents is higher in scenario 3, rather than scenario 4. However, the winter gardens contribute to decrease the energy demand of the existing buildings, and as a consequence, the photovoltaic panels needed to cover the remaining energy need. Though, it has been stated that by considering the final photovoltaic cost, scenario 4 is still more feasible than scenario 3, through the rents.

Concerning the sale approach, there is a linear correlation between new sqm to build and economic profit, as the equation is based on the subtraction between gains and losses.

## Technologic perspective

About the technologic feasibility, the Scheveningen Case Study represented a challenge, considering the structure to sustain the rooftop additions. Firstly, it had to be stated if the existing building needed interventions of adjustment, concerning the seismic regulation. The site is located in a low seismic risk area, so consolidation interventions on the existing could be avoided. Nevertheless, the choice of the structure to sustain the addition represented a tough step of the research. Firstly, the structure of the rooftop additions is different from the existing buildings. The former is made of wood, while the latter is a brick wall construction. Even if the wooden structure is usually light, the structural elements to carry the upper loads must be chosen. Finally, it was decided to let an external steel structure collaborate with the existing cross brick walls, opting for a solution that would not be suitable for an Italian case study, because of the higher seismic risk.

## 8.2 Recommendations

### 8.2.1 Recommendations for further research

The thesis studies the application of the add-ons strategy on a case study from the architect and engineer's point of view. This methodology should be approached from the point of views of the various stakeholders involved in the energy and architectural renovation of the building. The main goal is to draw the guidelines in order to create a specific market, based on the energy refurbishment of existing buildings through the add-ons strategy. In order to do this, it is required to standardise and categories main approaches in order to obtain a model recognised as valuable.

The recommendations for further research are explained below:

- To have a more detailed knowledge of the buildings, having the possibility to outline the actual architectural components' layers during an inspection;
- To have a more specific knowledge about the actual energy consumption of the buildings, by considering not only the heating system, but also the rest of the energy demand. To have the possibility to consult the past years' energy bills;
- To use a calculation model recognised as valuable by all ABRACADABRA partners, and to state the actual architectural components' thermal transmittances also with the help of simulations;
- To verify the feasibility of the economic and volumetric scenarios by consulting the different investment stakeholders;
- To calculate the exact bill of quantities for the project, refurbishment and new construction, in order to verify and adapt the economic and volumetric scenarios on the base of the actual costs.

### 8.2.2 Recommendations for other practices

The main guidelines stated by the process can be as an example for other practices, by considering the analysis of the case study, the calculation of the energy demand, the elaboration of the economic scenarios with fixed possible additions and the design phase. Nevertheless, for each case there will be different real estate market values and different investment approaches, depending on the ownership. Also, the types of additions will be chosen between the ABRACADABRA standards depending on the physical boundaries of the site. The conclusion however, is that the economic feasibility of the investment is the very first goal to achieve, carried on with a reasonable and sustainable design process, that gives rather than deprives value from the existing housing stock.

## 9 Bibliography

Wright F. L., 1939. *An Organic Architecture: The architecture of democracy*, Boston, The MIT Press;

Filippidou F., Nieboer N.E.T., Visscher H.J., forthcoming. *Energy efficiency measures implemented in the Dutch non-profit housing sector*, *Energy and Buildings*;

Van Bueren E.M., Van Bohemen H., Itard L., Visscher H.J., 2012. *Sustainable Urban Environments An Ecosystem Approach*, Netherlands, Springer;

Baldiri T., Rahola S., 2015. *Integrated project delivery methods for energy renovation of social housing*, Delft University of Technology, Faculty of Architecture and the Built environment, OTB – Research for the built environment;

Ferrante, A., 2016. Towards Nearly Zero Energy. Urban Settings in the Mediterranean Climate, Butterworth-Heinemann;

Laurent M.H., Allibe B., Tigchelaar C., Oreszczyn T., Hamilton I., Galvin R., 2013. Back to reality: How domestic energy efficiency policies in four European countries can be improved by using empirical data instead of normative calculation, eceee Summer Study proceedings, pp. 2057-2070;

Annunziata E., Frey M., Rizzi F., 2013. Towards nearly zero-energy buildings: The state-of-art of national regulations in Europe, Energy, Volume 57, pp. 125-133;

Saheb Y., 2015. Energy Transition of the EU Building Stock. Unleashing the 4<sup>th</sup> Industrial Revolution in Europe, OpenExp, Rod Janssen;

EEA Report No 6/2014, 2014. Trends and projections in Europe 2014. Tracking progress towards Europe's climate and energy targets for 2020, Luxembourg, Publications Office of the European Union;

EEA Report No 4/2015, 2015. Trends and projections in Europe 2015. Tracking progress towards Europe's climate and energy targets, Luxembourg, Publication Office of the European Union;

Klunder G., 2005. Sustainable solutions for Dutch housing. Reducing the environmental impacts of new and existing houses, DUP Science, Delft University of Technology, Faculty of Architecture and the Built Environment, OTB-Research for the Built Environment;

Itard L., Meijer F., 2008. Towards a sustainable Northern European housing stock. Figures, Facts and future, IOS Press, Delft University of Technology, Faculty of Architecture and the Built Environment, OTB-Research for the Built Environment;

Lerner J., 2014. Urban Acupuncture. Celebrating Pinpricks of Change that Enrich City Life, Washington, Island Pr;

Toffler A., 1980. The Third Wave, New York City, Bantam Books;

Nillesen A.L., Singelenberg J., 2011. Waterwonen in Nederland. Amphibious Housing in the Netherlands, Rotterdam, NAI uitgevers;

Gerdes J., 2015. Energy Efficiency trends and policies in the Netherlands, Amsterdam, ECN;

Ramaji I.J., Memari A.M., 2016. Product Architecture model for multistory modular buildings, Penn State University, Journal of construction engineering and management, Volume 142, Issue 10;

Fitzsimons J., 2013. The Dutch private rented sector, Copenhagen, The Knowledge Centre for Housing Economics;

Capozzoli A., Gorrino A., Corrado V., 2013. Thermal characterization of green roofs through dynamic simulation, 13th Conference of International Building Performance Simulation Association, Chambéry, France.

## 10 Sitography

<http://www.buildup.eu/en/practices/publications/dutch-decree-energy-performance-buildings-beg>

<https://www.nen.nl/About-NEN.htm>

<http://www.buildup.eu/en/learn/notes/review-dutch-energy-saving-covenant-social-dwellings>

[http://ec.europa.eu/clima/policies/international/negotiations/paris/index\\_en.htm](http://ec.europa.eu/clima/policies/international/negotiations/paris/index_en.htm)

<http://www.energiesprong.eu>

<http://stroomversnelling.nl>

<http://eur-lex.europa.eu>

[http://unfccc.int/kyoto\\_protocol/items/2830.php](http://unfccc.int/kyoto_protocol/items/2830.php)

[http://europa.eu/rapid/press-release\\_IP-12-1342\\_it.htm](http://europa.eu/rapid/press-release_IP-12-1342_it.htm)

<http://www.abracadabra-project.eu>

<https://ec.europa.eu/programmes/horizon2020/en/what-horizon-2020>

<http://it.climate-data.org>

<http://www.denhaag.nl>

<http://www.cfmoller.com>

<http://www.druot.net>

<http://www.sanmarco.it>

<http://globalpropertyguide.com>